

European ApHC and NSBA International Championships 2024

Hunt Seat Equitation Novice Non Pro/Amateur and Novice Youth

Show Date: 09-24-2024

w w w . H o r s e S h o w P a t t e r n s . c o m

w w w . H o r s e S h o w P a t t e r n s . c o m

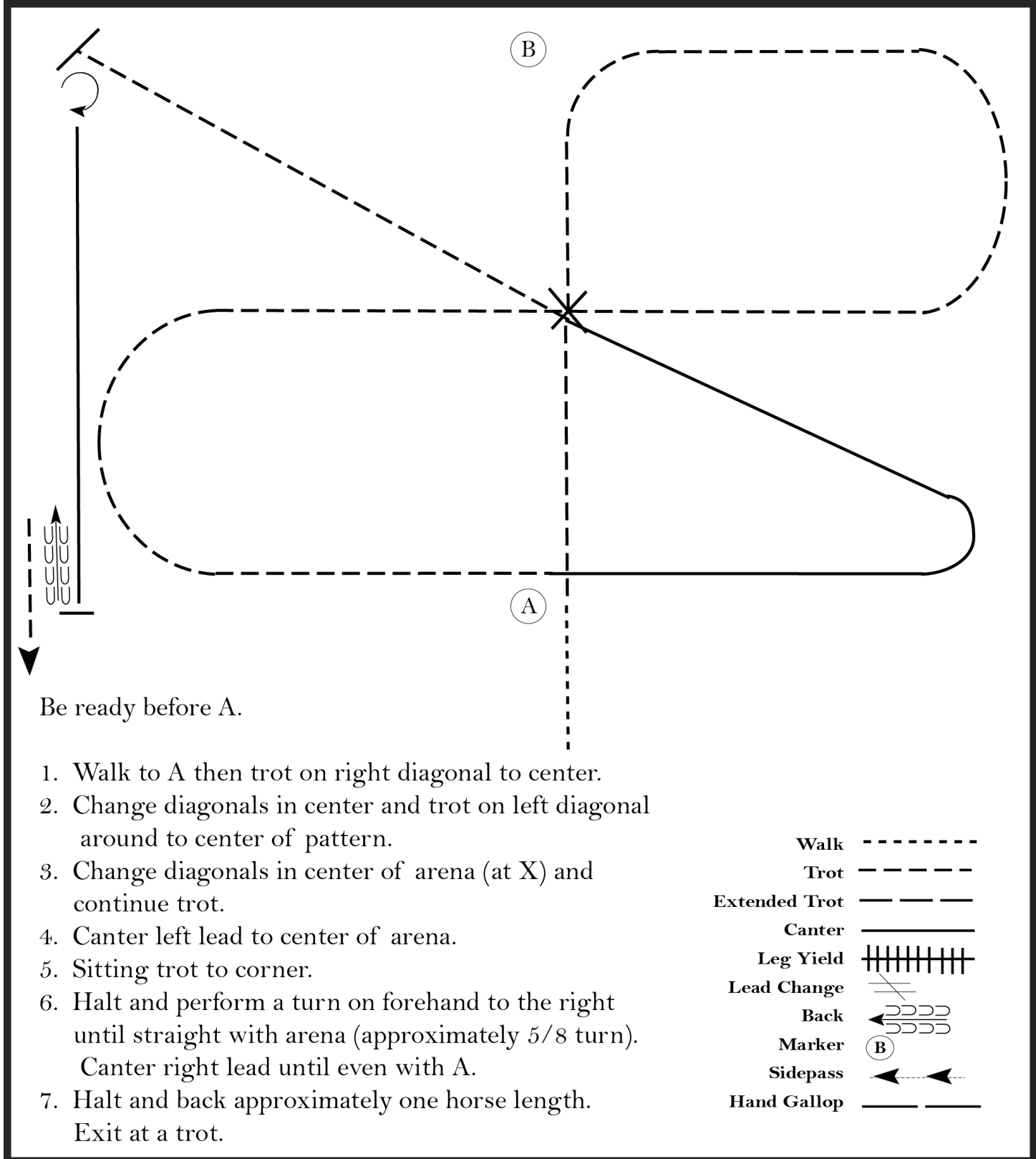

Be ready before A.

1. Walk to A then trot on right diagonal to center.
2. Change diagonals in center and trot on left diagonal around to center of pattern.
3. Change diagonals in center of arena (at X) and continue trot.
4. Canter left lead to center of arena.
5. Sitting trot to corner.
6. Halt and perform a turn on forehand to the right until straight with arena (approximately 5/8 turn).
Canter right lead until even with A.
7. Halt and back approximately one horse length.
Exit at a trot.

Walk	-----
Trot	- - - - -
Extended Trot	-----
Canter	—————
Leg Yield	
Lead Change	↙ ↘
Back	← ← ← ← ←
Marker	(B)
Sidepass	← ← ← ← ←
Hand Gallop	-----

[HSE/1-113]

Pattern Provided by:

European ApHC and NSBA International Championships 2024

Hunt Seat Equitation Non Pro/Amateur and Youth

Show Date: 09-24-2024

w w w . H o r s e S h o w P a t t e r n s . c o m

w w w . H o r s e S h o w P a t t e r n s . c o m

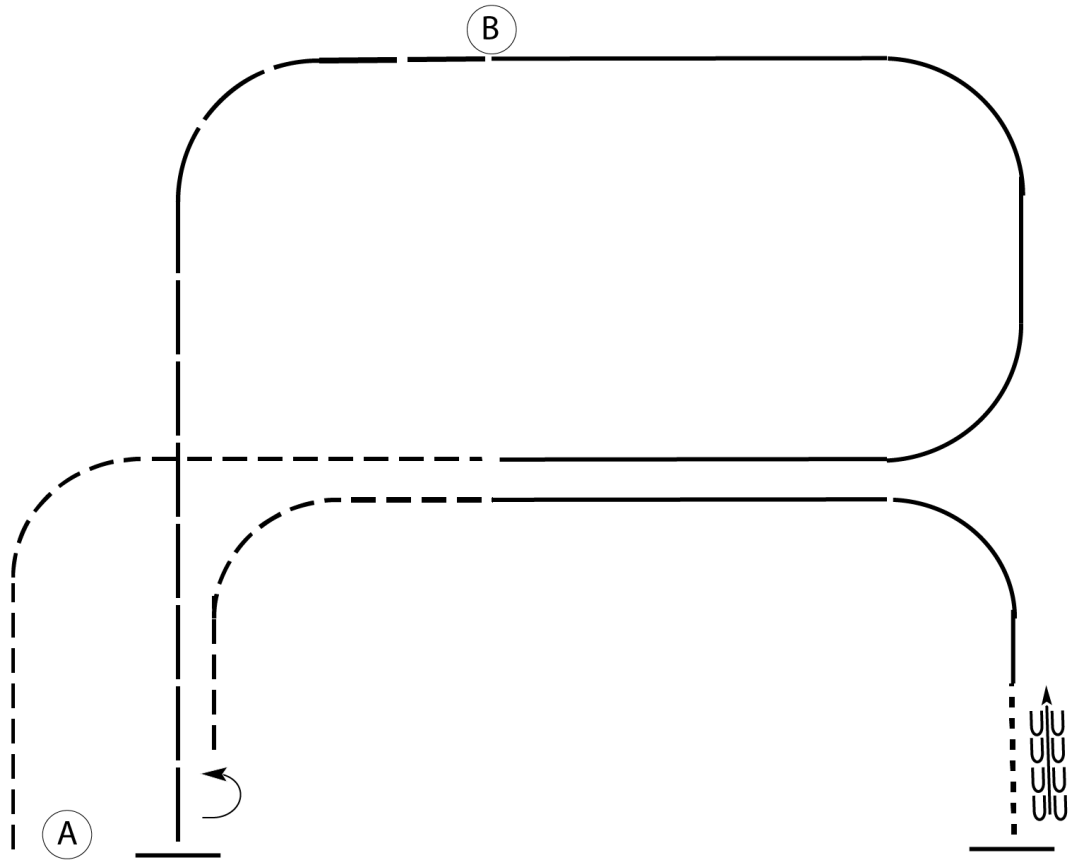

Be ready at A.

1. Trot on the left diagonal to center of pattern.
2. Canter on the left lead to B.
3. Hand gallop until even with A and stop.
4. Perform a 180 degree turn on the forehand to the left to change direction.
5. Sitting trot to center of pattern.
6. Canter on the right lead around corner.
7. Forward walk until even with A.
8. Stop and back.

Pattern is complete.

Walk	-----
Trot	- - - - -
Extended Trot	-----
Canter	—————
Leg Yield	
Lead Change	↙ ↘
Back	← ← ← ← ←
Marker	⊙
Sidepass	← — — — — →
Hand Gallop	-----

[HSE/3-115]

Pattern Provided by:

European ApHC and NSBA International Championships 2024

Hunt Seat Equitation Walk Trot Non Pro/Amateur and Youth

Show Date: 09-24-2024

www.HorseShowPatterns.com

www.HorseShowPatterns.com

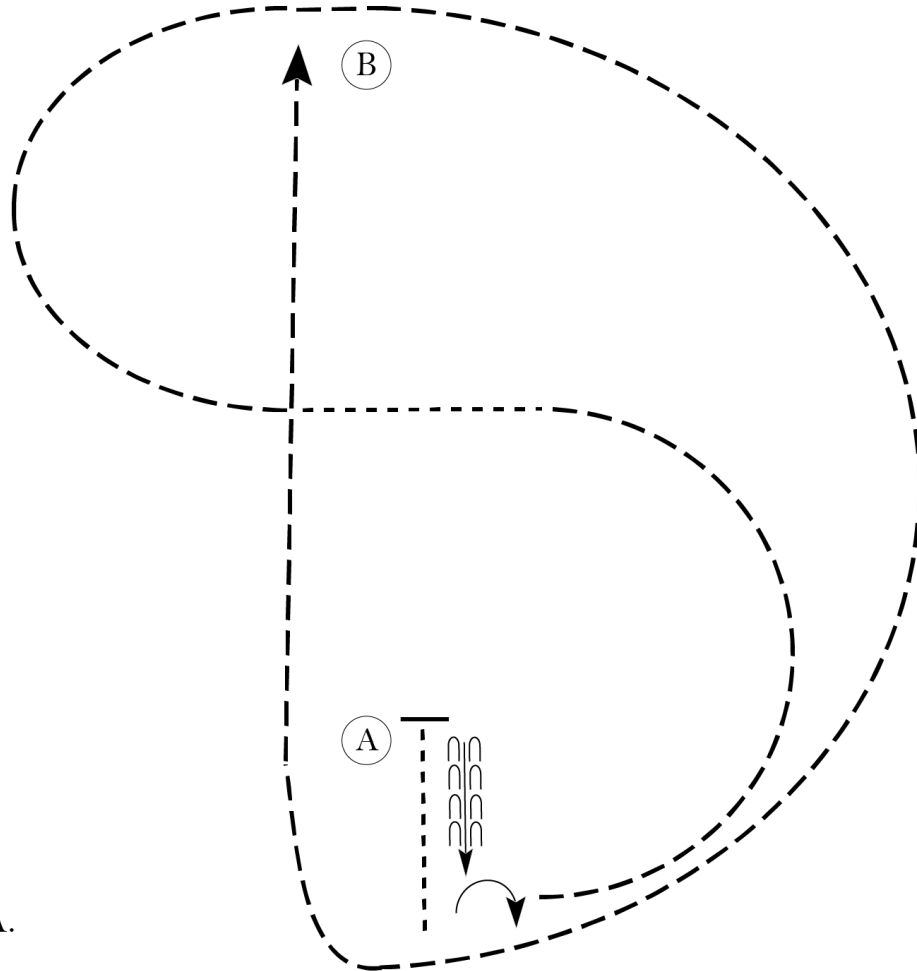

Be ready before A.

1. Walk to A, stop and back approximately one horse length.
2. Perform a 90 degree forehand turn right.
3. Trot on the right diagonal in a half circle to center of pattern.
4. Walk 2-3 horse lengths.
5. Sitting trot in a half circle to B.
6. Trot on the left diagonal to and around A.
7. Continue to trot on the left diagonal to B.

Pattern is over once you pass B.

Walk	-----
Trot	- - - - -
Extended Trot	-----
Canter	—————
Leg Yield	
Lead Change	↙ ↘
Back	← ← ← ← ←
Marker	⊙
Sidepass	← ← ← ← ←
Hand Gallop	-----

[HSE/WT-67]

Pattern Provided by:

European ApHC and NSBA International Championships 2024 Ranch Riding Green Open

Show Date: 09-24-2024

w w w . H o r s e S h o w P a t t e r n s . c o m

w w w . H o r s e S h o w P a t t e r n s . c o m

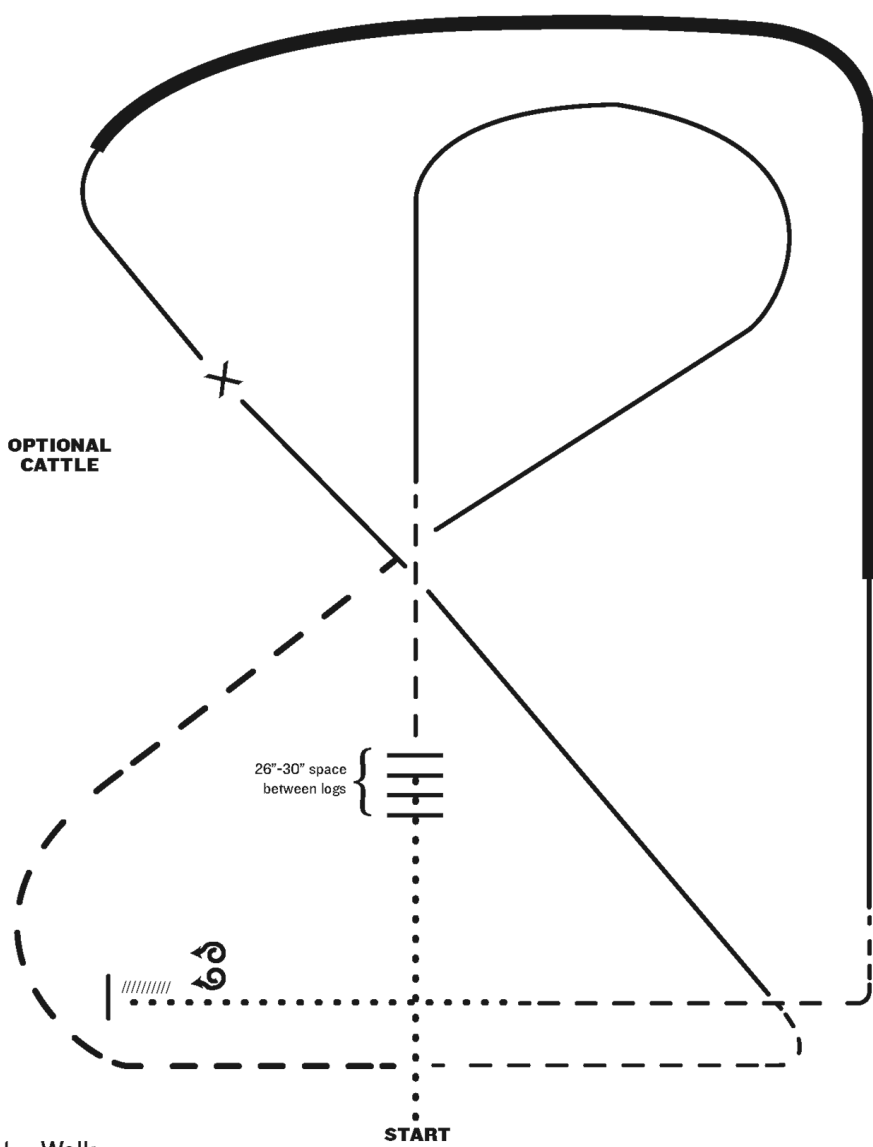

1. Walk
2. Walk over logs
3. Trot
4. Lope right lead
5. Extended trot
6. Trot
7. Lope left lead
8. Change leads (simple or flying)
9. Right lead, extended lope
10. Collect Lope
11. Trot
12. Walk
13. Stop and back
14. 360 degree turn each direction (either direction 1st) (L-R or R-L)

Note: The drawn description of this pattern is only intended for the general depiction of the pattern. Exhibitors should utilize the arena space to best exhibit their horses.

[RR/AQHA-5]

Pattern Provided by:

European ApHC and NSBA International Championships 2024

Ranch Riding Novice Non-Pro/Amateur and Novice Youth

Show Date: 09-24-2024

www.HorseShowPatterns.com

www.HorseShowPatterns.com

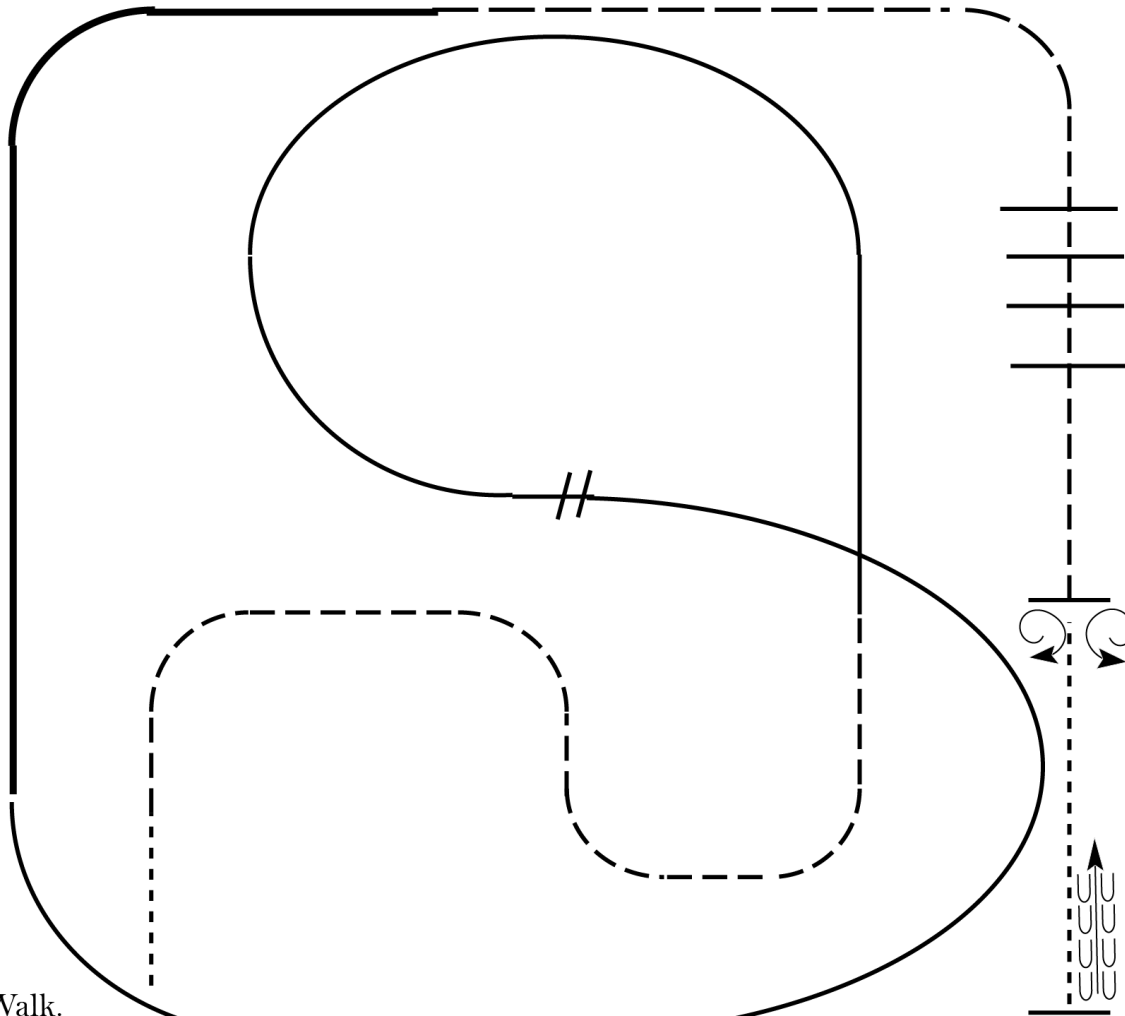

1. Walk.
2. Trot serpentine
3. Lope left lead around end of arena and then diagonally across arena.
4. Change leads (simple or flying) and
5. Lope on the right lead around end of the arena.
6. Extend lope on the straight away around corner to center of arena.
7. Extend trot around corner of arena
8. Collect to a trot
9. Trot over poles
10. Stop do a 360 turn each direction (either direction 1st)
11. Walk, stop and back.

Walk	-----
Jog	- - - - -
Extended Jog	— — — — —
Lope	
Lead Change	⧘
Back	← ← ← ← ←
Marker	Ⓚ

[RR/4]

Pattern Provided by:

European ApHC and NSBA International Championships 2024 Ranch Riding Open

Show Date: 09-24-2024

w w w . H o r s e S h o w P a t t e r n s . c o m

w w w . H o r s e S h o w P a t t e r n s . c o m

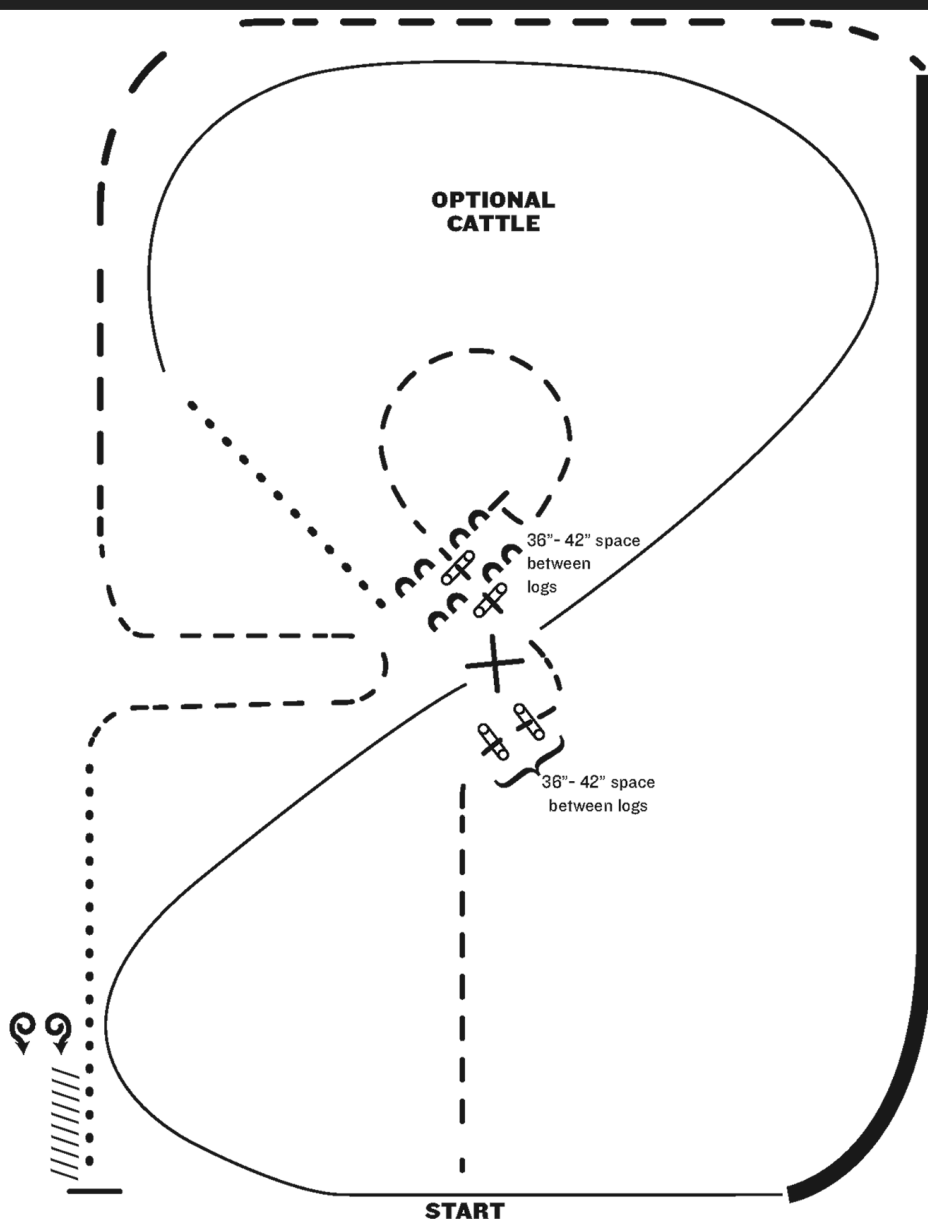

1. Trot
2. Trot two sets of logs
3. Trot circle, stop and side pass log left
4. Walk
5. Lope right lead
6. Change leads (simple or flying)
7. Lope left lead
8. Extended lope (left lead)
9. Extended trot
10. Trot
11. Walk
12. Stop and back
13. 360 degree turn each direction (either direction 1st) (L-R or R-L)

Note: The drawn description of this pattern is only intended for the general depiction of the pattern. Exhibitors should utilize the arena space to best exhibit their horses.

[RR/AQHA-9]

Pattern Provided by:

European ApHC and NSBA International Championships 2024

Ranch Riding Non-Pro/Amateur and Youth

Show Date: 09-24-2024

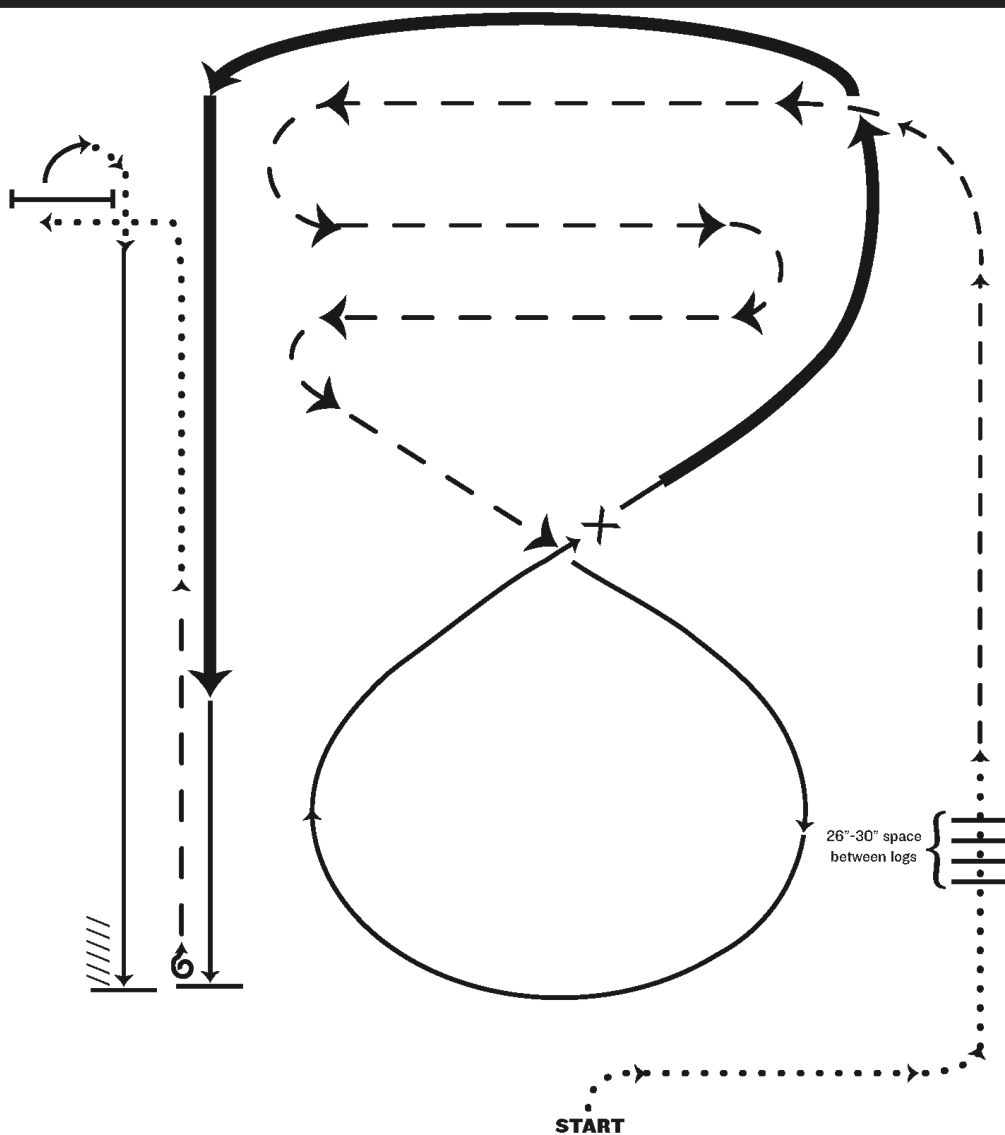

1. Walk
2. Walk over logs
3. Trot
4. Extended trot serpentine
5. Lope right lead
6. Change leads (simple or flying)
7. Extended lope (left lead), collect lope
8. Stop, 1 1/2 turn, either direction
9. Trot
10. Walk to gate
11. Right hand push gate
12. Walk, lope left lead
13. Stop and back

Note: The drawn description of this pattern is only intended for the general depiction of the pattern. Exhibitors should utilize the arena space to best exhibit their horses.

[RR/AQHA-13]

Pattern Provided by:

European ApHC and NSBA International Championships 2024 Ranch Riding EAF Futurity

Show Date: 09-24-2024

w w w . H o r s e S h o w P a t t e r n s . c o m

w w w . H o r s e S h o w P a t t e r n s . c o m

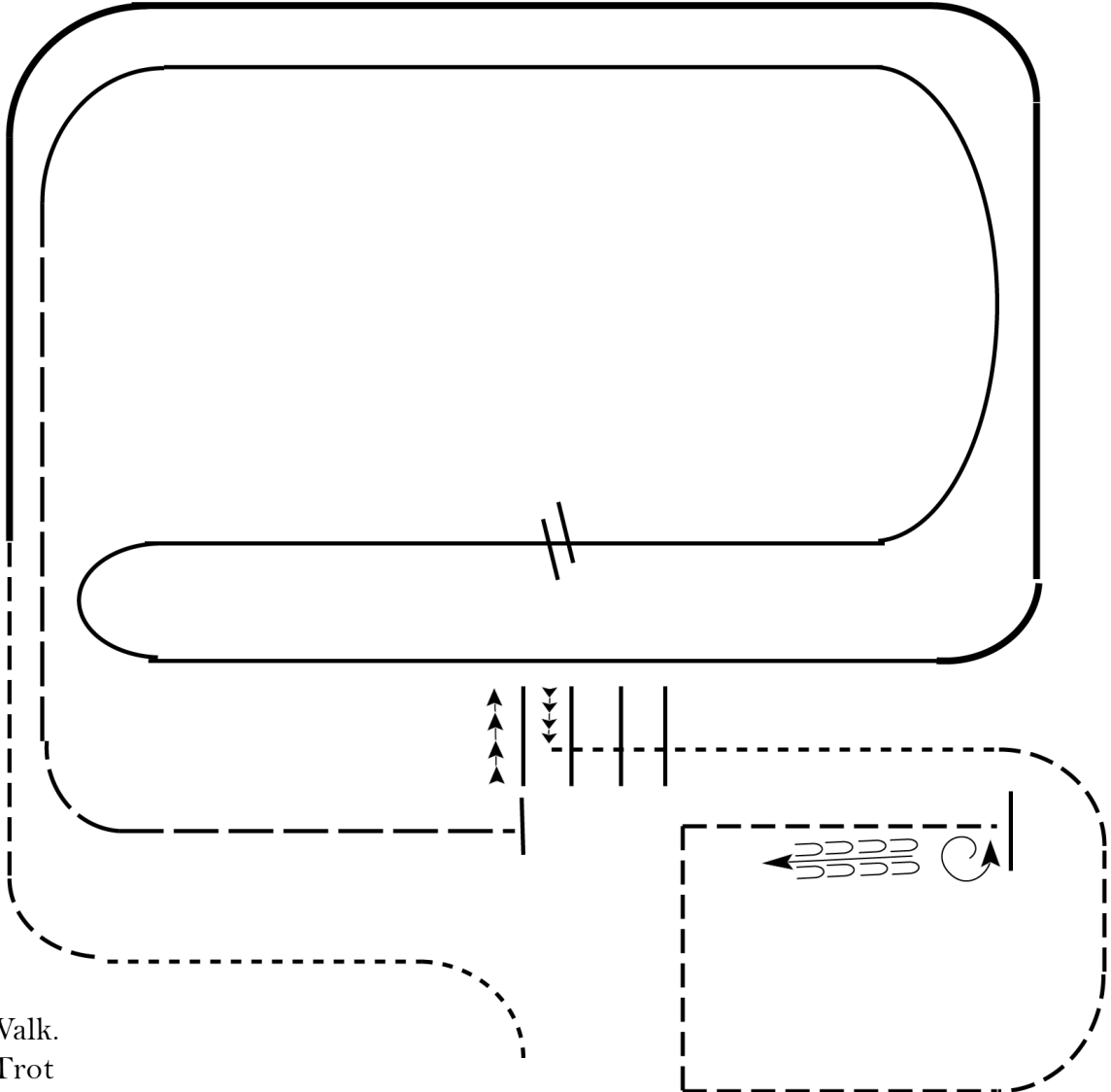

1. Walk.
2. Trot
3. Extended lope-right lead
4. Lope right lead
5. Change leads (simple or flying)
6. Lope left lead
7. Extended trot
8. Stop, side pass left, side pass right, 1/2 way
9. Walk over logs
10. Walk
11. Trot square
12. Stop, 360 degree turn left, back

- Walk
- Jog
- Extended Jog
- Lope
- Lead Change
- Back
- Marker

[RR/5]

Pattern Provided by:

European ApHC and NSBA International Championships 2024 Ranch Riding EAF Maturity

Show Date: 09-24-2024

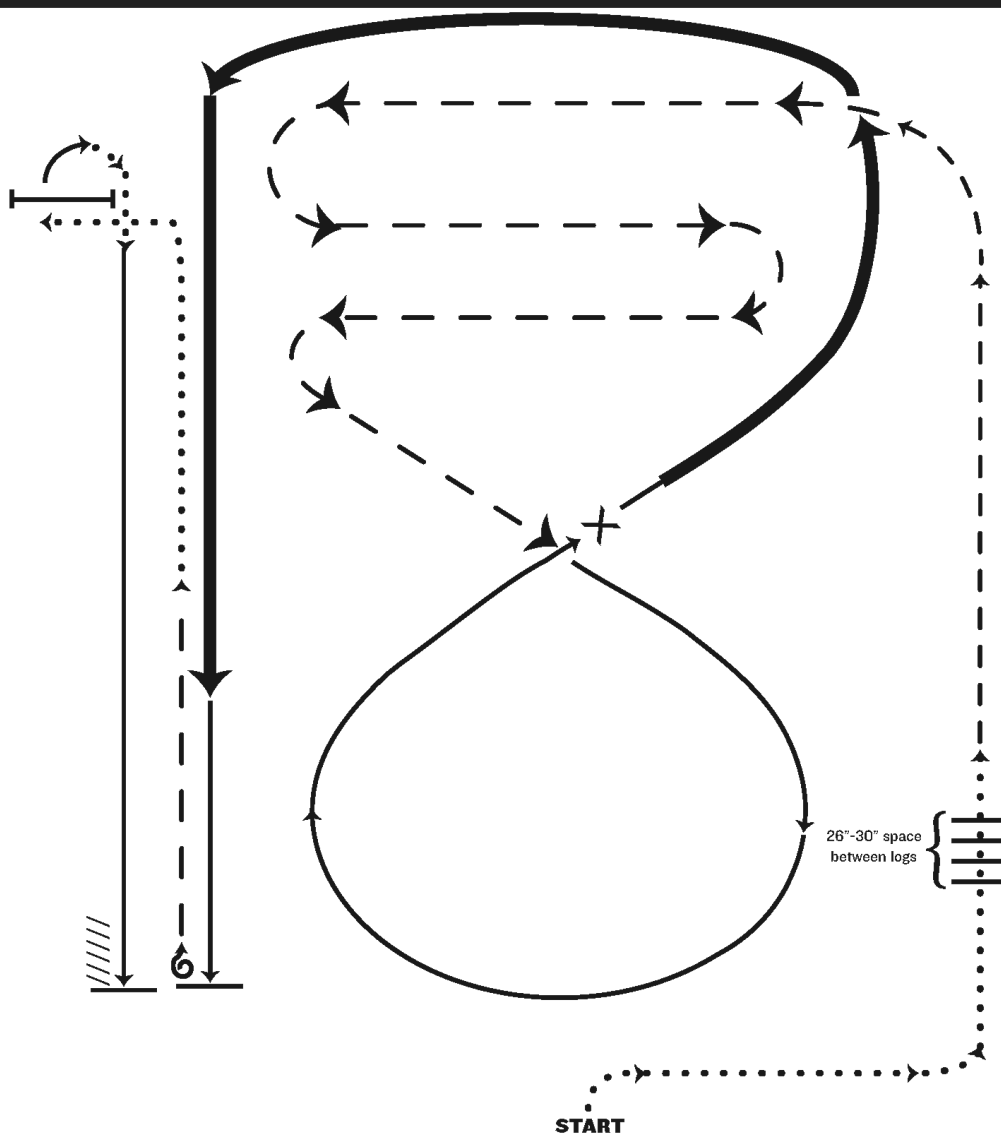

1. Walk
2. Walk over logs
3. Trot
4. Extended trot serpentine
5. Lope right lead
6. Change leads (simple or flying)
7. Extended lope (left lead), collect lope
8. Stop, 1 1/2 turn, either direction
9. Trot
10. Walk to gate
11. Right hand push gate
12. Walk, lope left lead
13. Stop and back

Note: The drawn description of this pattern is only intended for the general depiction of the pattern. Exhibitors should utilize the arena space to best exhibit their horses.

[RR/AQHA-13]

Pattern Provided by:

European ApHC and NSBA International Championships 2024 Reining Non pro and Youth

Show Date: 09-24-2024

REINING PATTERN 2

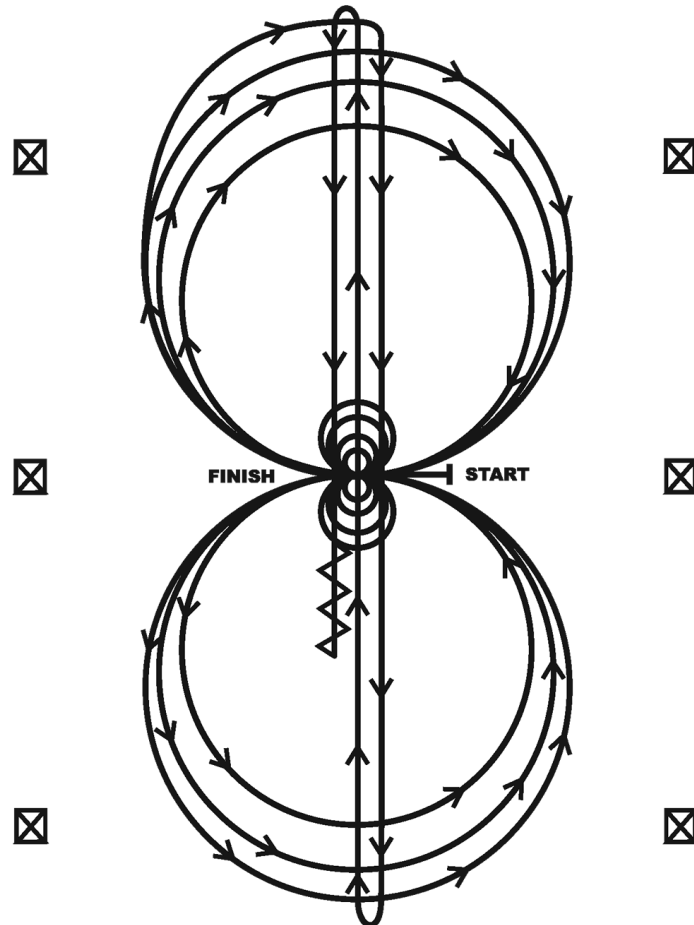

Horses may walk or jog to the center of arena. Horses must walk or stop prior to starting pattern. Beginning at the center of the arena facing the left wall or fence.

1. Beginning on the right lead, complete three circles to the right: the first circle small and slow; the next two circles large and fast. Change leads at the center of the arena.
2. Complete three circles to the left: the first circle small and slow; the next two circles large and fast. Change leads at the center of the arena.
3. Continue around previous circle to the right. At the top of the circle, run down the middle to the far end of the arena past the end marker and do a right rollback—no hesitation.
4. Run up the middle to the opposite end of the arena past the end marker and do a left rollback—no hesitation.
5. Run past the center marker and do a sliding stop. Back up to the center of the arena or at least ten feet (three meters). Hesitate.
6. Complete four spins to the right. Hesitate.
7. Complete four spins to the left. Hesitate to demonstrate the completion of the pattern.

[R/AQHAP-2]

Pattern Provided by:

European ApHC and NSBA International Championships 2024 Reining Novice Non Pro

Show Date: 09-24-2024

REINING PATTERN 11

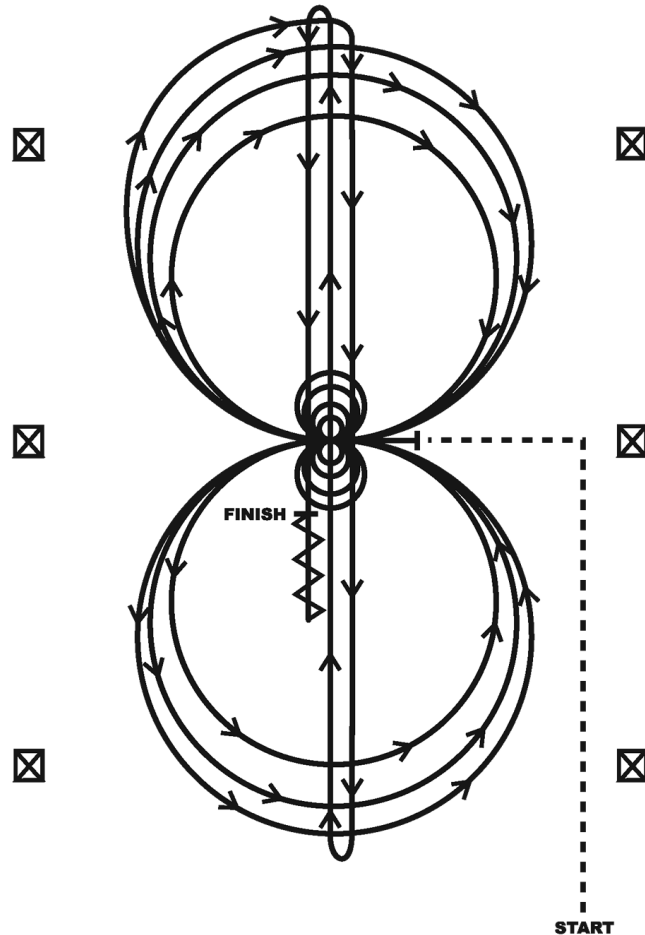

Horses must jog to the center of the arena. Horses must walk or stop prior to starting the pattern. Beginning at the center of the arena facing the left wall or fence.

1. Complete four spins to the left. Hesitate.
2. Complete four spins to the right. Hesitate.
3. Beginning on the right lead complete three circles to the right; the first circle small and slow; the next two circles large and fast. Change leads at the center of the arena.
4. Complete three circles to the left; the first circle small and slow; the next two circles large and fast. Change leads at the center of the arena.
5. Begin a large circle to the right, but do not close this circle. Run down the center of the arena past the end marker and do a right rollback—no hesitation.
6. Run up the middle to the opposite end of the arena past the end marker and do a left rollback—no hesitation.
7. Run past the center marker and do a sliding stop. Back up to the center of the arena or at least ten feet (three meters). Hesitate to demonstrate completion of the pattern.

[R/AQHAP-11]

Pattern Provided by:

European ApHC and NSBA International Championships 2024 Reining Open

Show Date: 09-24-2024

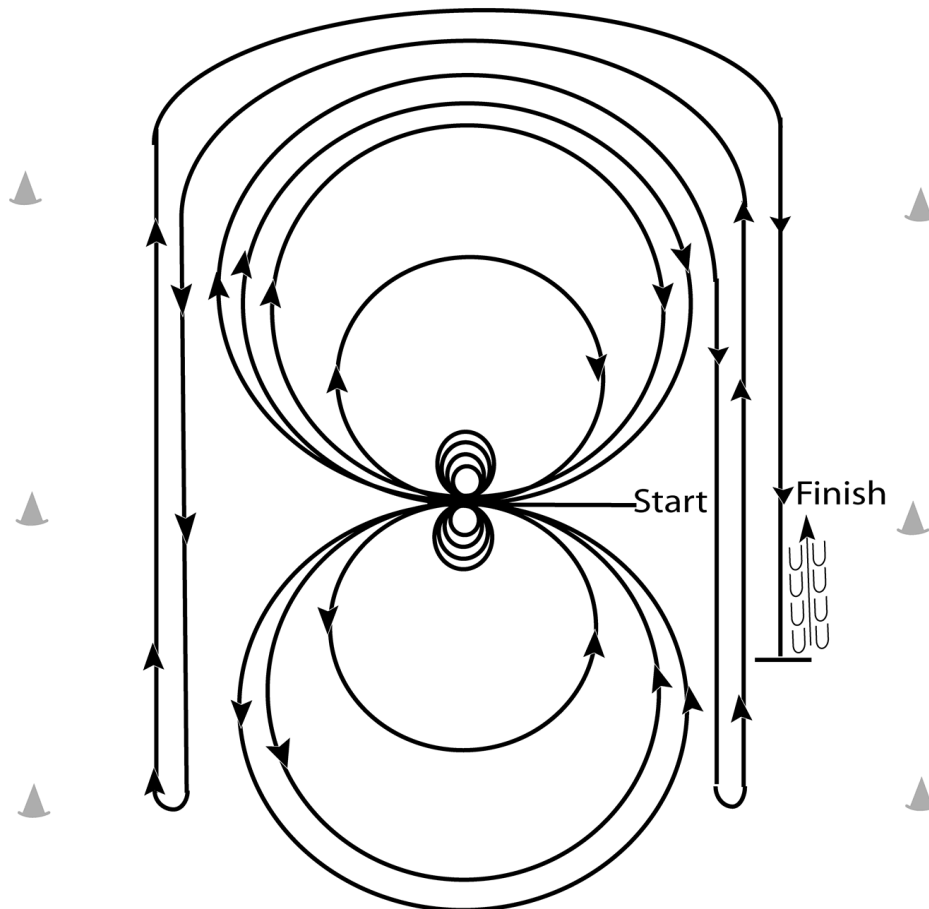

Horses may walk or trot to the center of the arena. Beginning at the center of the arena facing the left wall or fence.

1. Complete four spins to the left.
 2. Complete four spins to the right. Hesitate.
 3. Beginning on the right lead, complete three circles to the right: the first circle large and fast; the second circle small and slow; the third circle large and fast. Change leads at the center of the arena.
 4. Complete three circles to the left: the first circle large and fast; the second circle small and slow; the third circle large and fast. Change leads at the center of the arena.
 5. Begin a large fast circle to the right but do not close this circle. Run straight down the right side of the arena past the center marker and do a left rollback at least twenty feet (6.09m) from the wall or fence – no hesitation.
 6. Continue back around the previous circle but do not close this circle. Run down the left side of the arena past the center marker and do a right rollback at least twenty feet (6.09m) from the wall or fence – no hesitation.
 7. Continue back around the previous circle but do not close this circle. Run down the right side of the arena past the center marker and do a sliding stop at least twenty feet (6.09m) from the wall or fence. Back up at least ten feet (3m). Hesitate to demonstrate completion of the pattern.
- Rider may dismount and drop bridle to the designated judge.

[R/NRHAP-8]

Pattern Provided by:

European ApHC and NSBA International Championships 2024 Reining EAF Futurity

Show Date: 09-24-2024

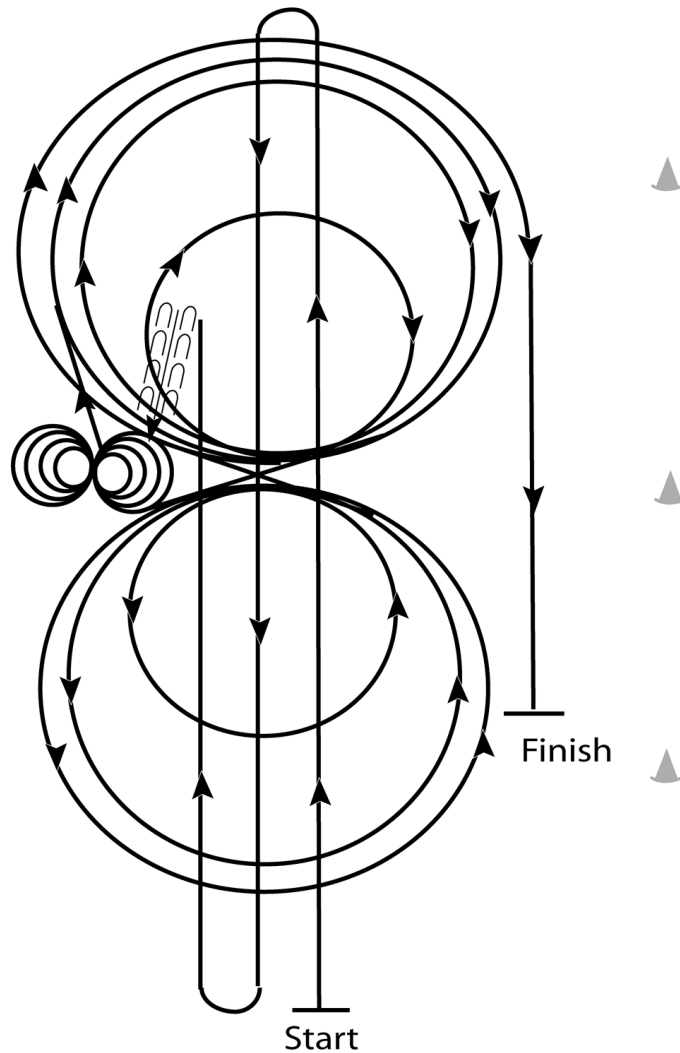

1. Run at speed to the far end of the arena past the end marker and do a left rollback – no hesitation.
2. Run to the opposite end of the arena past the end marker and do a right rollback – no hesitation.
3. Run past the center marker and do a sliding stop. Back up to the center of the arena at least ten feet (3m). Hesitate.
4. Complete four spins to the right.
5. Complete four and one-quarter spins to the left so that horse is facing left wall or fence. Hesitate.
6. Beginning on the right lead, complete three circles to the right: the first two circles large and fast; the third circle small and slow. Change leads at the center of the arena.
7. Complete three circles to the left: the first two circles large and fast; the third circle small and slow. Change leads at the center of the arena.
8. Begin a large fast circle to the right but do not close this circle. Run straight down the right side of the arena past the center marker and do a sliding stop at least twenty feet (6.09m) from the wall or fence. Hesitate to demonstrate completion of the pattern.
Rider may dismount and drop bridle to the designated judge.

[R/NRHAP-7]

Pattern Provided by:

European ApHC and NSBA International Championships 2024 Reining EAF Maturity

Show Date: 09-24-2024

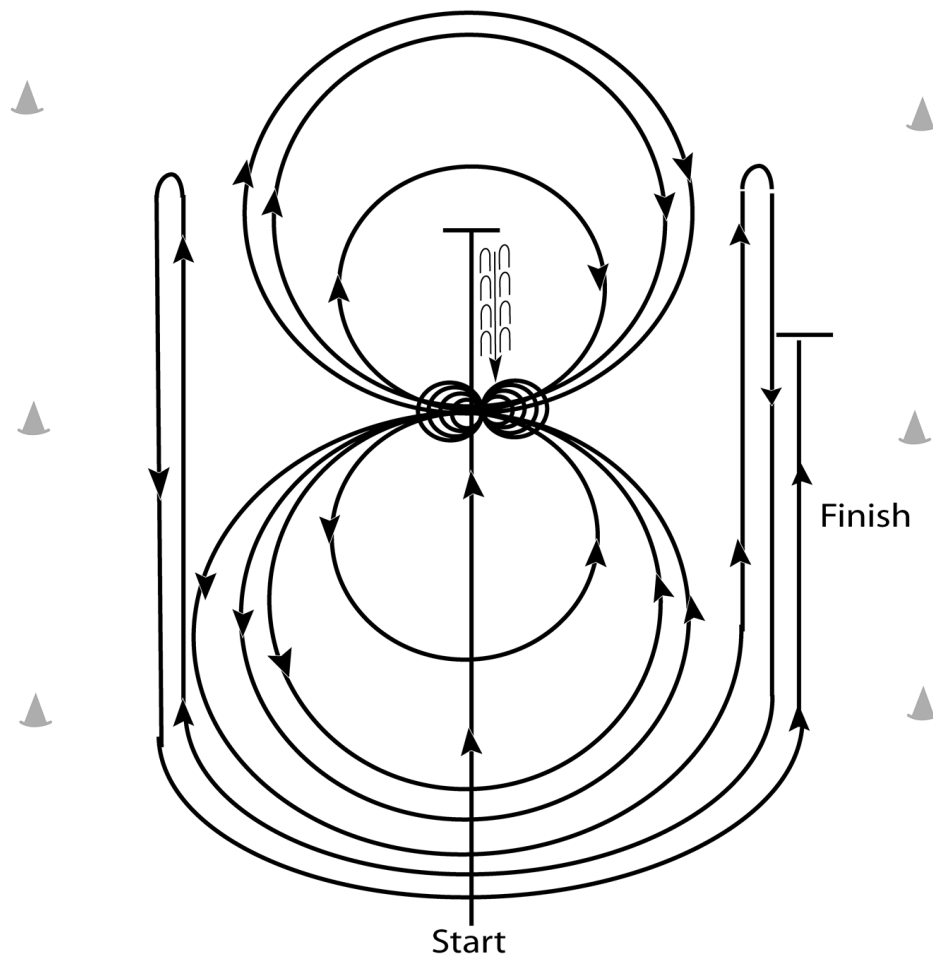

1. Run past the center marker and do a sliding stop. Back up to the center of the arena or at least ten feet (3m). Hesitate.
 2. Complete four spins to the right.
 3. Complete four and one-quarter spins to the left so that horse is facing the left wall or fence. Hesitate.
 4. Beginning on the left lead, complete three circles to the left: the first circle small and slow; the next two circles large and fast. Change leads at the center of the arena.
 5. Complete three circles to the right: the first circle small and slow; the next two circles large and fast. Change leads at the center of the arena.
 6. Begin a large fast circle to the left but do not close this circle. Run up the right side of the arena past the center marker and do a right rollback at least twenty feet (6.09m) from the wall or fence – no hesitation.
 7. Continue back around the previous circle but do not close this circle. Run up the left side of the arena past the center marker and do a left rollback at least twenty feet (6.09m) from the wall or fence – no hesitation.
 8. Continue back around previous circle but do not close this circle. Run up right side of the arena past the center marker and do a sliding stop at least twenty feet (6.09m) from the wall or fence. Hesitate to demonstrate completion of the pattern.
- Rider may dismount and drop bridle to the designated judge.

[R/NRHAP-9]

Pattern Provided by:

European ApHC and NSBA International Championships 2024

Showmanship At Halter Novice Non-Pro/Amateur and Novice Youth

Show Date: 09-24-2024

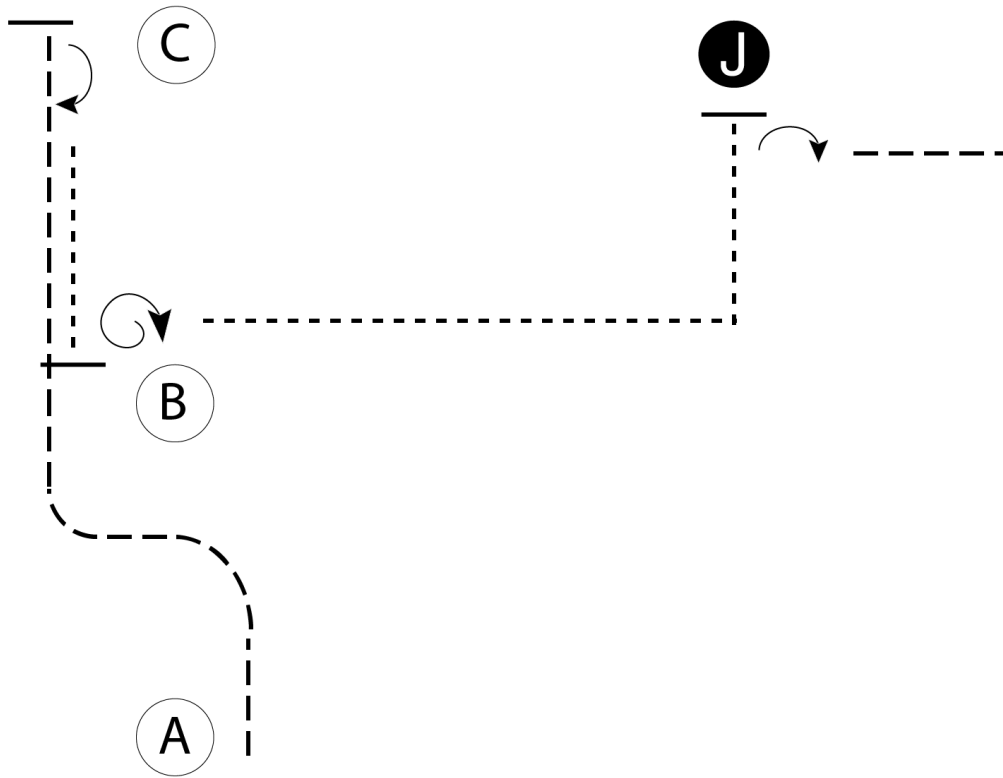

Be ready at A.

1. Trot from A until even with C and stop.
2. Perform a 180 degree turn.
3. Walk with forward motion until just before B.
4. Perform a 270 degree turn.
5. Walk a square corner to Judge.
6. Set Up.
7. Inspection.
8. When dismissed, perform a 90 degree turn and pattern is complete.

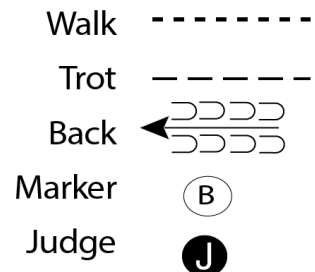

[S/1-121]

Pattern Provided by:

European ApHC and NSBA International Championships 2024

Showmanship At Halter Non-Pro/Amateur and Youth

Show Date: 09-24-2024

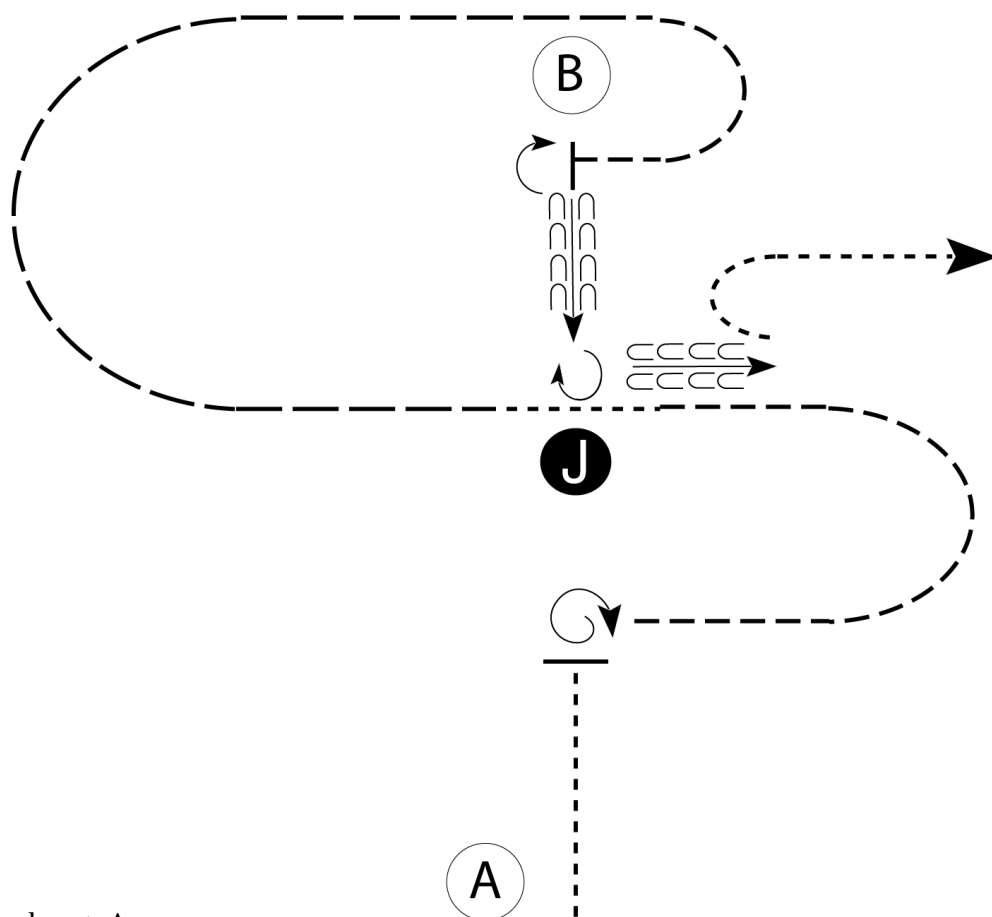

Be ready at A.

1. Walk halfway to Judge, stop and perform a 450 degree turn.
2. Trot a half circle. Break to a walk and walk at least two horse lengths in front of judge.
3. Extended trot in a half circle to B.
4. Trot around B as shown.
5. Stop at B and perform a 90 degree turn.
6. Back to Judge, stop and set up for inspection.
7. When dismissed, perform a 270 degree turn.
8. Back two horse lengths and exit at a walk as shown.

Follow the instructions of your ring steward.

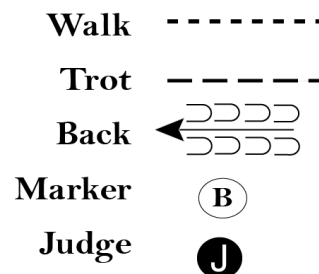

[S/3-88]

Pattern Provided by:

European ApHC and NSBA International Championships 2024

Showmanship W/T Non-Pro/Amateur and Youth

Show Date: 09-24-2024

w w w . H o r s e S h o w P a t t e r n s . c o m

w w w . H o r s e S h o w P a t t e r n s . c o m

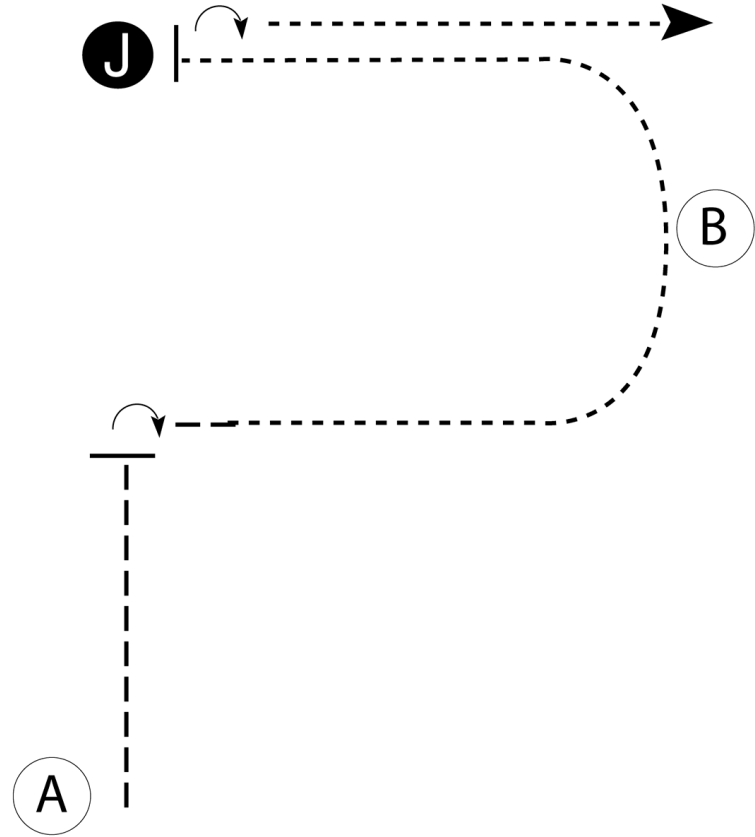

Be ready at A.

1. When acknowledged, trot to judge.
2. Stop and perform a 90 degree turn.
3. Walk around to judge as shown.
4. Stop and set up for inspection.
5. When dismissed, perform a 180 degree turn.
6. Walk straight away to exit.

Follow the instructions of your ring steward.

Walk	-----
Trot	- - - - -
Back	← ㄩ ㄩ ㄩ ㄩ
Marker	⊙ B
Judge	● J

[S/WT-64]

Pattern Provided by:

European ApHC and NSBA International Championships 2024

Horsemanship Novice Non-Pro/Amateur and Novice Youth

Show Date: 09-24-2024

w w w . H o r s e S h o w P a t t e r n s . c o m

w w w . H o r s e S h o w P a t t e r n s . c o m

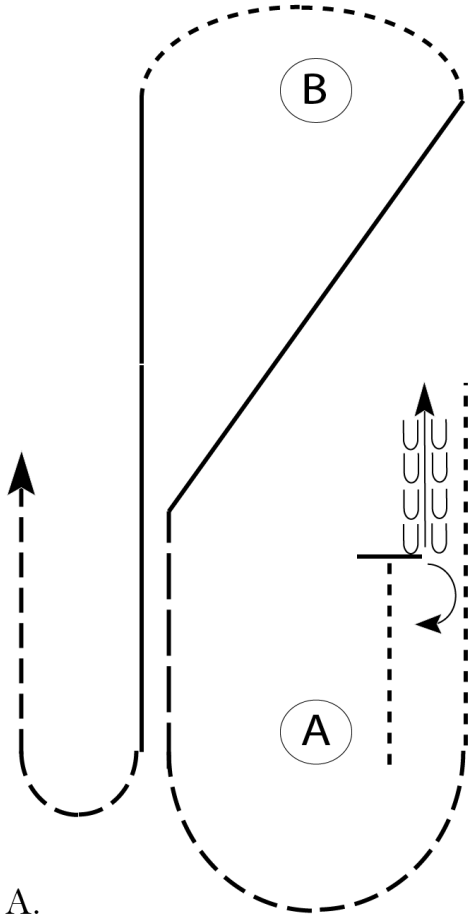

Be ready at A.

1. Walk approximately 2 horse lengths from A.
Stop and perform a 1/2 turn right.
2. Back approximately one horse length then walk to A.
3. Jog around A then extend the jog in a straight line halfway to B.
4. Lope on the left lead on the diagonal to B.
Break to the walk and walk around B.
5. Lope on the right lead to A.
6. Break to the jog when even with A and jog around to exit.

Walk	-----
Jog	- - - - -
Extended Jog	- - - - -
Lope	—————
Lead Change	⋈
Back	← ← ← ← ←
Marker	Ⓚ

[WH/1-117]

Pattern Provided by:

European ApHC and NSBA International Championships 2024

Western Horsemanship Bareback Amateur and Youth

Show Date: 09-24-2024

w w w . H o r s e S h o w P a t t e r n s . c o m

w w w . H o r s e S h o w P a t t e r n s . c o m

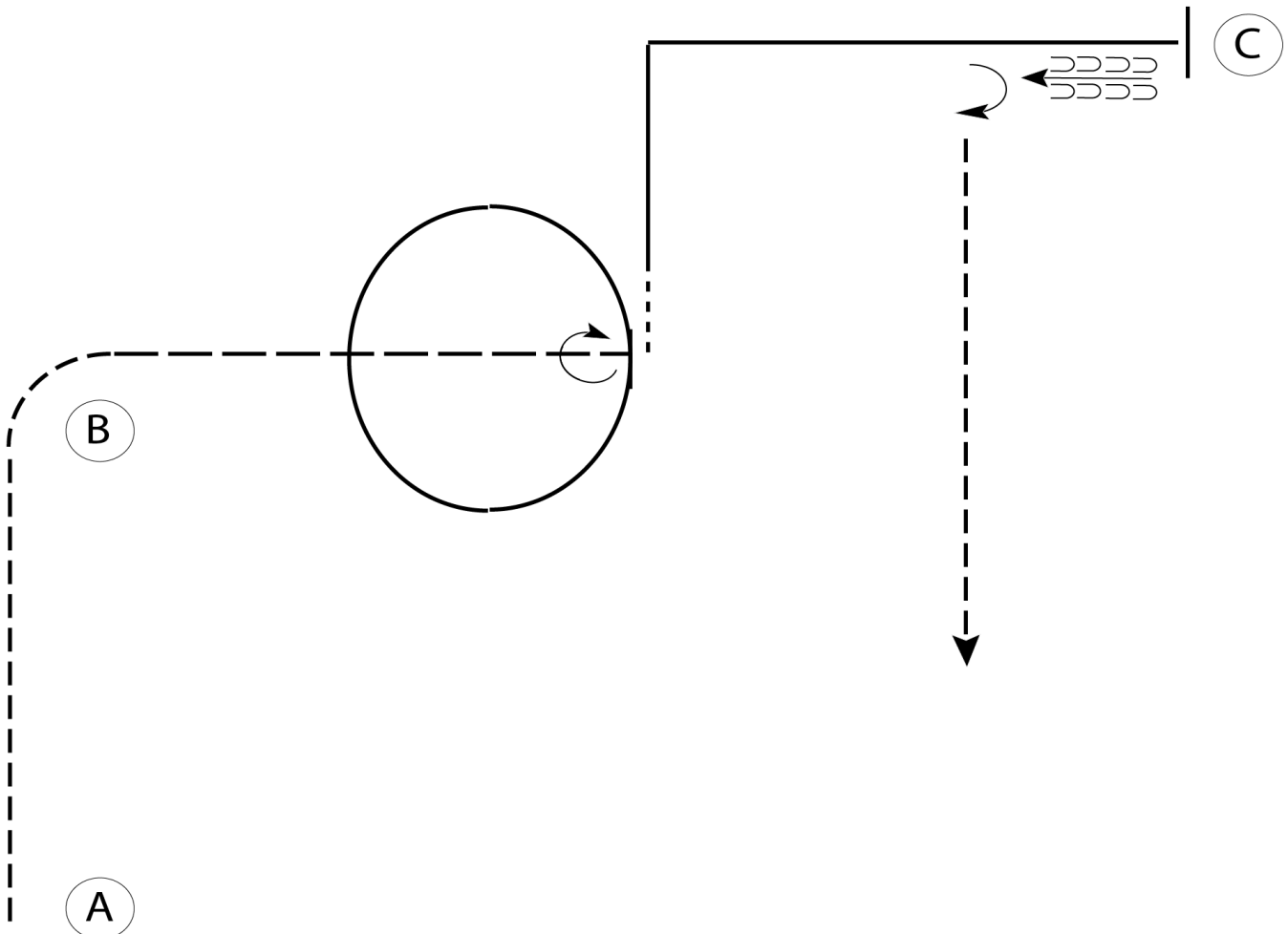

Be ready at A.

1. Jog to and around B.
2. Extend the jog to the middle of your pattern.
3. Perform a 3/4 turn right.
4. Perform a small left lead lope circle.
5. Break to a walk and walk approximately 2 horse lengths.
6. Lope on the right lead and lope a square corner to C.
7. Stop and back.
8. Perform a 1/4 turn right.
9. Jog to exit.

Walk	-----
Jog	- - - - -
Extended Jog	- - - - -
Lope	=====
Lead Change	
Back	
Marker	

[WH/2-107]

Pattern Provided by:

European ApHC and NSBA International Championships 2024

Horsemanship Non-Pro/Amateur and Youth

Show Date: 09-24-2024

w w w . H o r s e S h o w P a t t e r n s . c o m

w w w . H o r s e S h o w P a t t e r n s . c o m

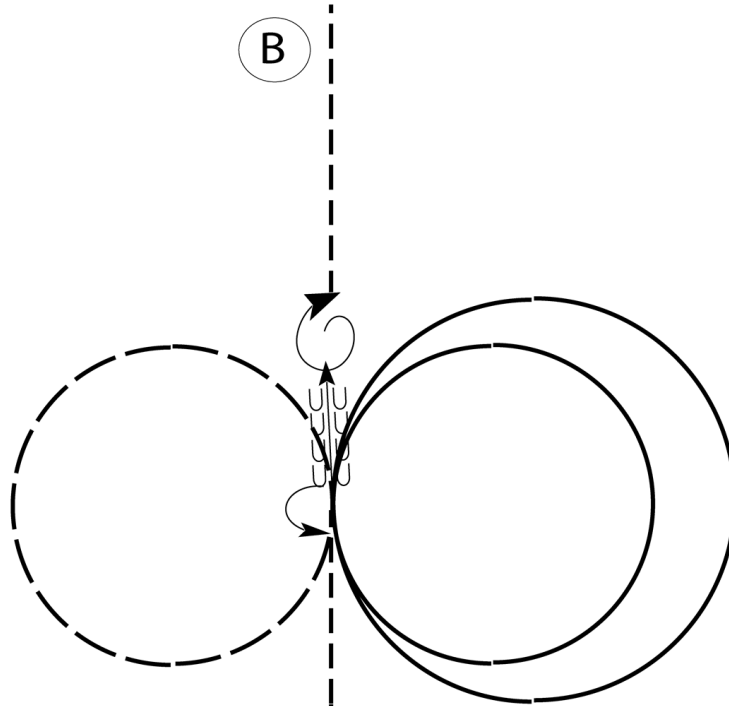

Be ready at A.

1. Walk halfway to center.
2. Jog to center.
3. Lope a circle to the right.
4. Lope a larger, faster circle to the right.
5. Extended jog circle to the left.
6. Stop at center.
7. Spin 1/2 a turn to the left.
8. Back approximately one horse length.
9. Spin 1 1/2 turns to the right.
10. Jog to B.

Pattern is over once you have passed B at the jog.

Follow the directions of your ring steward.

Walk	-----
Jog	- - - - -
Extended Jog	- - - - -
Lope	—————
Lead Change	— / —
Back	← — — — —
Marker	⊙ B

[WH/3-75]

Pattern Provided by:

European ApHC and NSBA International Championships 2024

Horsemanship Walk Trot Non-Pro/Amateur and Youth

Show Date: 09-24-2024

w w w . H o r s e S h o w P a t t e r n s . c o m

w w w . H o r s e S h o w P a t t e r n s . c o m

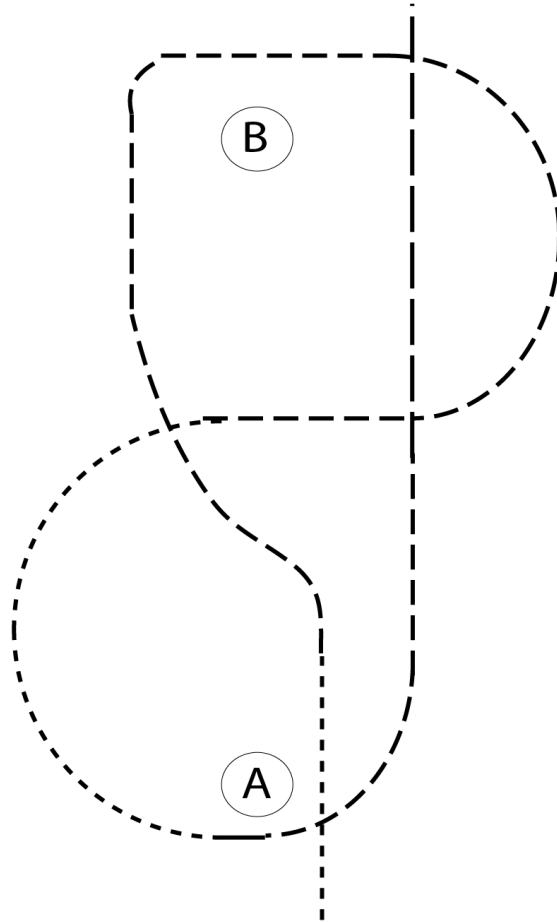

Be ready before A.

1. Walk approximately 2 horse lengths from A.
2. Jog to and around B as shown.
3. Jog a half circle to center of pattern.
4. Break to a walk and walk a half circle to A.
5. Jog from A halfway to B.
6. Extend the jog to and past B.

Pattern is over once you have passed B.

Follow the instructions of your ring steward.

Walk	-----
Jog	- - - - -
Extended Jog	— — — —
Lope	
Lead Change	↙ ↘
Back	← ← ← ← ←
Marker	⊙ B

[WH/WT-96]

Pattern Provided by:

European ApHC and NSBA International Championships 2024

Western Riding Green Open and Novice Non-Pro/Amateur

Show Date: 09-24-2024

LEVEL I WESTERN RIDING PATTERN 9

LEGEND

.....	Walk
- - - -	Jog
————	Lope
//////	Back
▬▬▬▬	Lead Changing Area

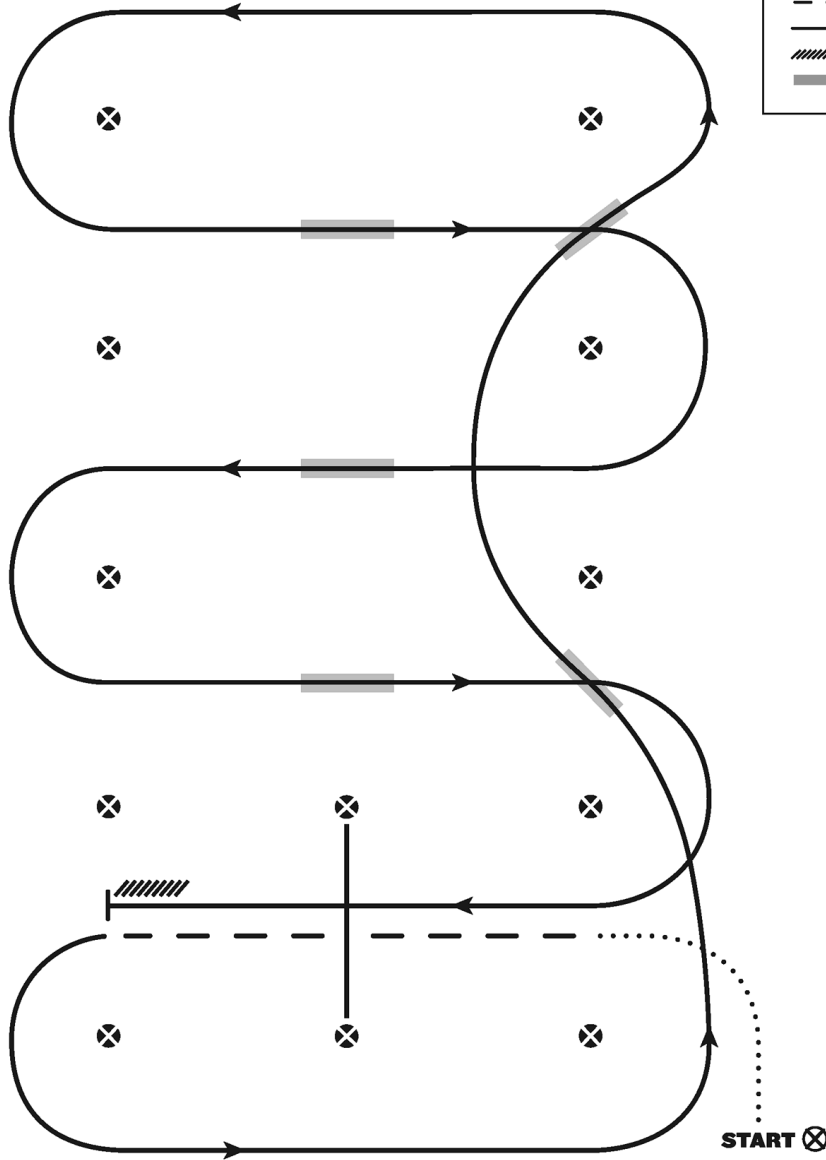

1. Walk at least 15 feet from start cone to the first marker, as drawn, transition to jog, jog over log.
2. Transition to the lope left lead & lope around end
3. First line change
4. Second line change, lope around the end of arena
5. First crossing change
6. Second crossing change
7. Third crossing change
8. Lope over log
9. Lope, stop & back

Revised 06-07-2021

[WR/GP-9]

Pattern Provided by:

