

Patterns Book

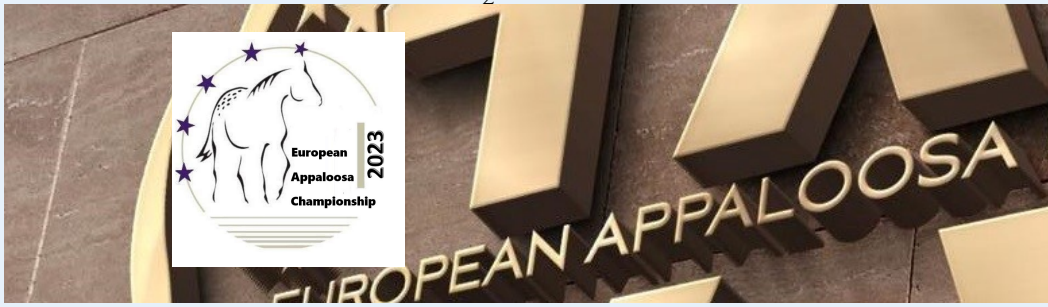

29 August—3
September 2023





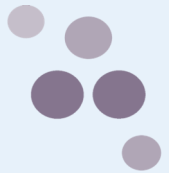

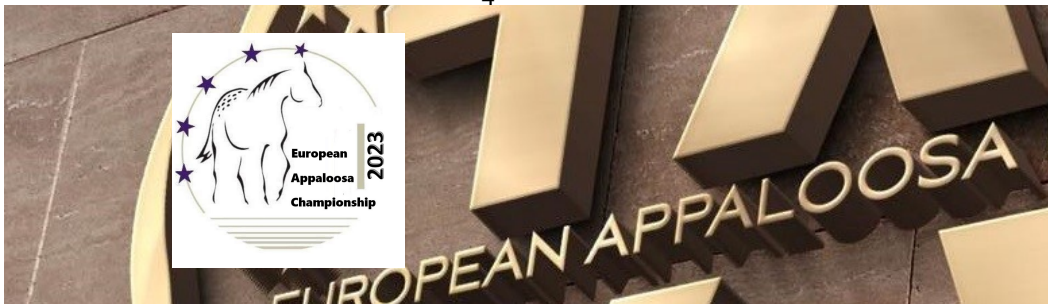

**2023 APPALOOSA
EUROPEAN CHAMPIONSHIP**

**ApHC YEARLING IN HAND TRAIL
NSBA YEARLING IN HAND TRAIL
NSBA AMATEUR YEARLING IN HAND TRAIL**

FRIDAY, SEPTEMBER 1

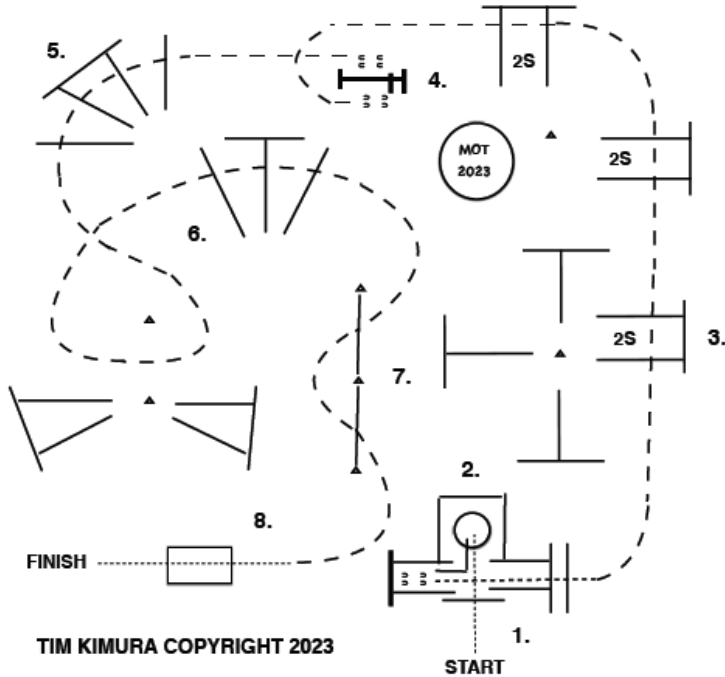

1. WALK OVER POLE AND WALK INTO CHUTE. EXECUTE A 360 TURN TO THE RIGHT.
2. BACK AROUND CORNER, BACK BETWEEN POLES. WALK OUT CHUTE, WALK OVER POLES.
3. JOG OVER POLES, JOG UP TO GATE.
4. WORK GATE LEFT HAND.
5. JOG OVER POLES.
6. JOG BETWEEN CONES, THEN JOG OVER POLES.
7. JOG THROUGH SERPENTINE, JOG OVER POLES.
8. STOP OR BREAK TO THE WALK, WALK OVER BRIDGE.



**2023 APPALOOSA
EUROPEAN CHAMPIONSHIP**

**ApHC GREEN TRAIL
ApHC TRAIL
NOVICE NON PRO**

THURSDAY, AUGUST 31

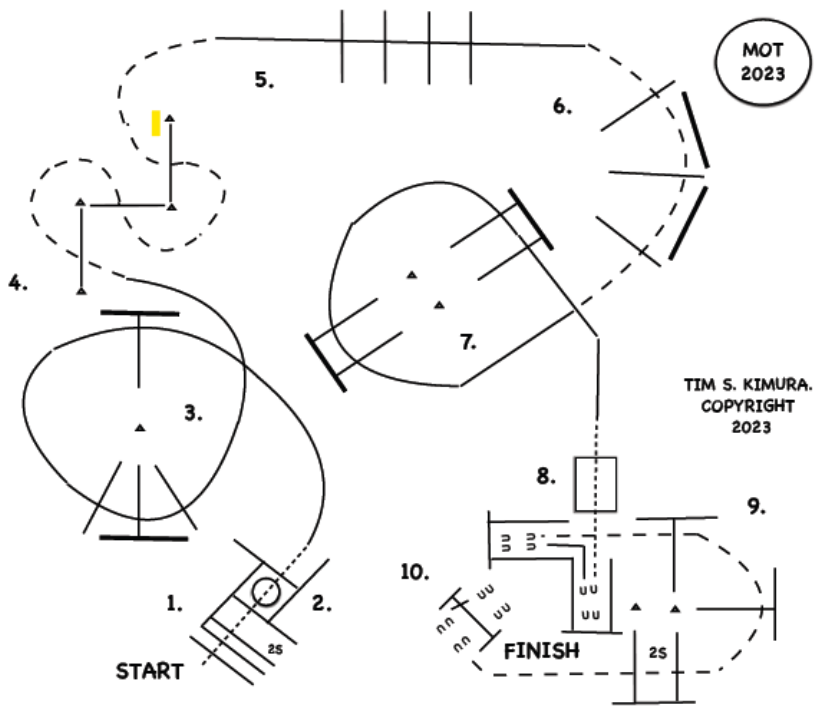

1. WALK OVER POLES, WALK INTO BOX.
2. EXECUTE A 360 TURN EITHER WAY, WALK OUT BOX.
3. LOPE OVER POLES (LEFT LEAD).
4. BREAK TO THE JOG, JOG THROUGH SERPENTINE, JOG OVER POLES.
5. LOPE OVER POLES (RIGHT LEAD),
6. BREAK TO THE JOG, JOG OVER POLES.
7. LOPE OVER POLES (RIGHT LEAD).
8. STOP OR BREAK TO THE WALK, WALK OVER BRIDGE, WALK INTO CHUTE, BACK "L", AROUND CORNER.
9. JOG OUT CHUTE, JOG OVER POLES, JOG UP TO GATE.
10. WORK GATE RIGHT HAND.





EUROPEAN APPALOOSA

2023 APPALOOSA EUROPEAN CHAMPIONSHIP

NSBA YOUTH TRAIL

FRIDAY, SEPTEMBER 1

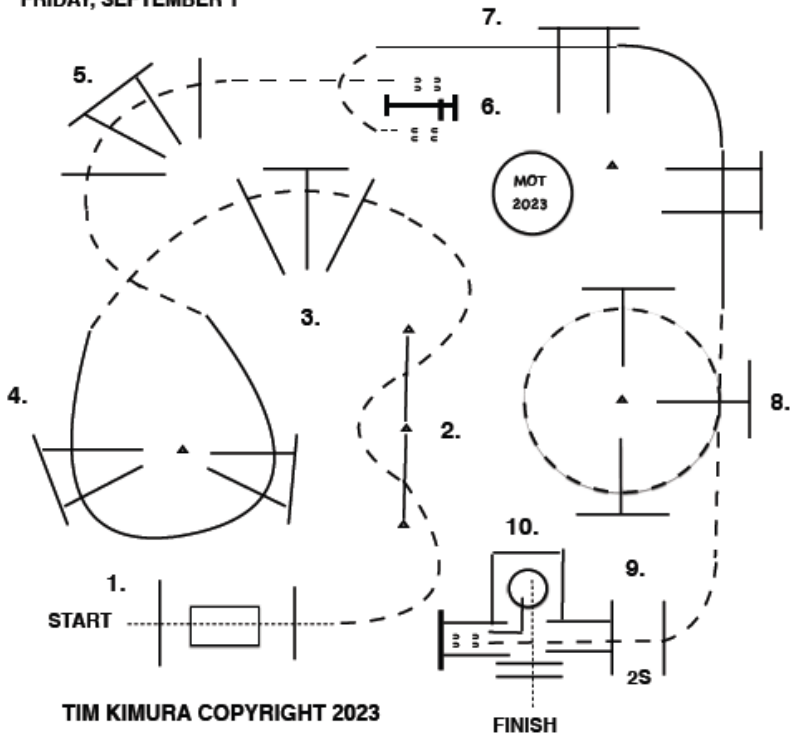

1. WALK OVER POLES AND WALK OVER BRIDGE.
2. JOG THROUGH SERPENTINE, JOG OVER POLES.
3. JOG OVER POLES.
4. LOPE OVER POLES (LEFT LEAD).
5. BREAK TO THE JOG, JOG OVER POLES, JOG UP TO GATE.
6. WORK GATE (RIGHT HAND).
7. WALK FORWARD, THEN JOG AROUND GATE, THEN LOPE OVER POLES (RIGHT LEAD).
8. BREAK TO THE JOG, JOG OVER POLES.
9. JOG OVER POLES, JOG INTO CHUTE, BACK INTO BOX.
10. EXECUTE A 360 TURN EITHER WAY, WALK OUT OVER POLES.







**2023 APPALOOSA
EUROPEAN CHAMPIONSHIP**

**NSBA YOUTH WALK TROT TRAIL
NSBA AMATEUR WALK TROT TRAIL**

FRIDAY, SEPTEMBER 1

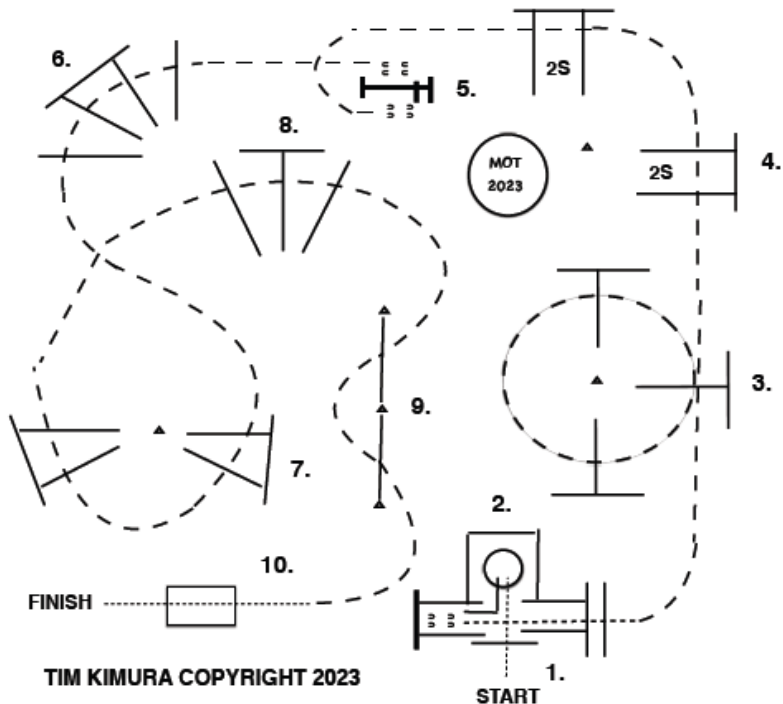

TIM KIMURA COPYRIGHT 2023

1. WALK OVER POLE AND WALK INTO CHUTE.
EXECUTE A 360 TURN EITHER WAY.
2. BACK AROUND CORNER, BACK BETWEEN POLES.
WALK OUT CHUTE, WALK OVER POLES.
3. JOG OVER POLES.
4. JOG OVER POLES, JOG UP TO GATE.
5. WORK GATE LEFT HAND.
6. JOG OVER POLES.
7. JOG OVER POLES.
8. JOG OVER POLES.
9. JOG THROUGH SERPENTINE, JOG OVER POLES.
10. STOP OR BREAK TO THE WALK, WALK OVER BRIDGE.





**2023 APPALOOSA
EUROPEAN CHAMPIONSHIP**

**ApHC TRAIL NON PRO
EAM OPEN TRAIL MATURITY**

FRIDAY, SEPTEMBER 1

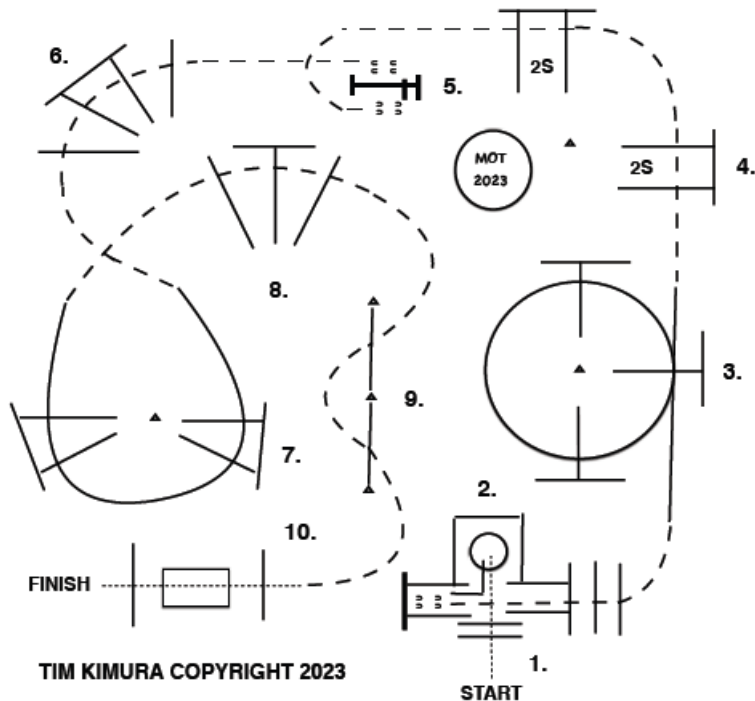

TIM KIMURA COPYRIGHT 2023

1. WALK OVER POLES AND WALK INTO CHUTE.
EXECUTE A 360 TURN EITHER WAY.
2. BACK AROUND CORNER, BACK BETWEEN POLES.
YOU MAY WALK FORWARD, THEN JOG OUT CHUTE, JOG OVER POLES.
3. LOPE OVER POLES (LEFT LEAD).
4. BREAK TO THE JOG, JOG OVER POLES.
5. JOG UP TO GATE, WORK GATE LEFT HAND.
6. LOPE OVER POLES (LEFT LEAD).
7. BREAK TO THE JOG, THEN LOPE OVER POLES (RIGHT LEAD).
8. BREAK TO THE JOG, JOG OVER POLES.
9. JOG THROUGH SERPENTINE, JOG OVER POLES.
10. STOP OR BREAK TO THE WALK, WALK OVER POLES.



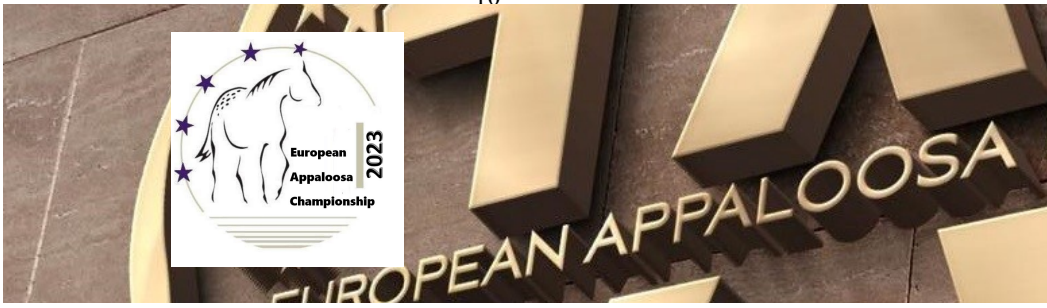

Trail Patterns by Tim Kimura are sponsored by :

Swiss Appaloosa



Schmid Performance Horses

www.swissappaloosa.ch





2023 APPALOOSA EUROPEAN CHAMPIONSHIP

NSBA ALL AGES TRAIL

SATURDAY, SEPTEMBER 2

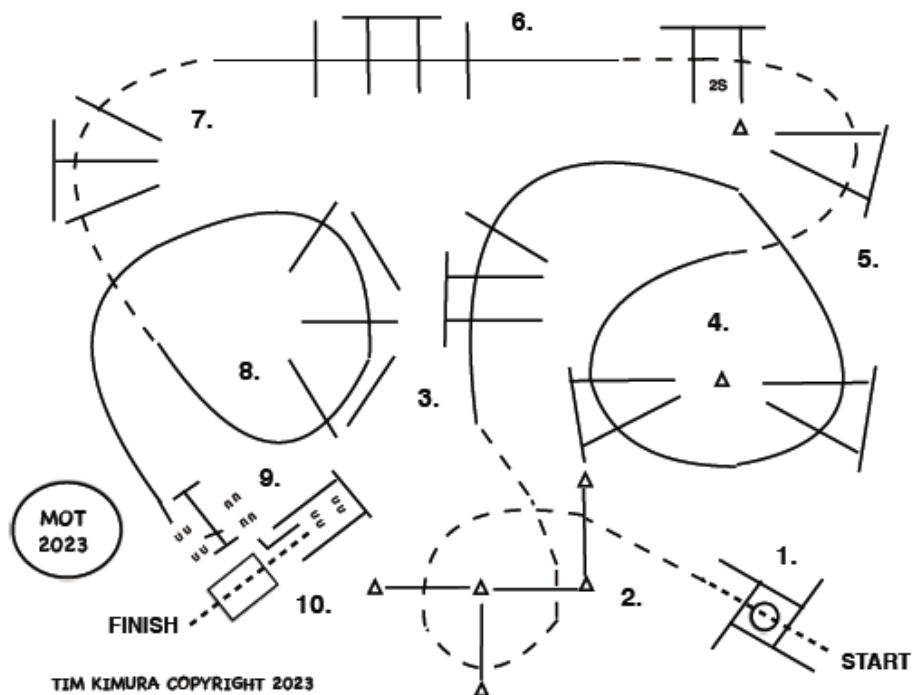

1. WALK INTO BOX, EXECUTE A 360 TURN EITHER WAY, WALK OUT BOX
2. JOG THROUGH SERPENTINE, JOG OVER POLES.
3. LOPE OVER POLES (RIGHT LEAD).
4. LOPE OVER POLES (RIGHT LEAD).
5. BREAK TO THE JOG, JOG OVER POLES.
6. LOPE OVER POLES (LEFT LEAD).
7. BREAK TO THE JOG, JOG OVER POLES.
8. LOPE OVER POLES (LEFT LEAD), LOPE UP TO GATE.
9. WORK GATE LEFT HAND.
10. BACK AROUND CORNER BETWEEN POLES, WALK OUT OVER BRIDGE.



European
Appaloosa
Championship
2023

2023 APPALOOSA EUROPEAN CHAMPIONSHIP

SATURDAY, SEPTEMBER 2

EAF OPEN 2 YO IN HAND TRAIL
NSBA OPEN 2 YO IN HAND TRAIL
NSBA AMATEUR 2 YO IN HAND TRAIL
NSBA 3 YO IN HAND TRAIL

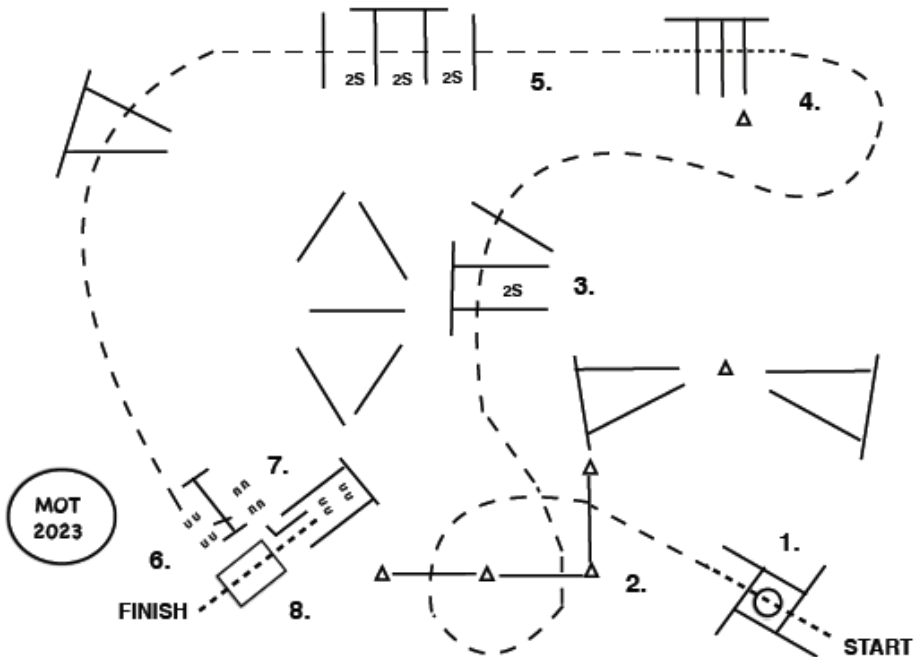

TIM KIMURA COPYRIGHT 2023

1. WALK INTO BOX, EXECUTE A 360 TURN RIGHT, WALK OUT BOX.
2. JOG THROUGH SERPENTINE, JOG OVER POLES.
3. JOG OVER POLES.
4. STOP OR BREAK TO THE WALK, WALK OVER POLES.
5. JOG OVER POLES, JOG UP TO GATE.
6. WORK GATE LEFT HAND.
7. BACK AROUND CORNER BETWEEN POLES.
8. WALK OUT OVER BRIDGE.

FOUNDATION



2023 APPALOOSA EUROPEAN CHAMPIONSHIP

ApHC SENIOR TRAIL

SATURDAY, SEPTEMBER 2

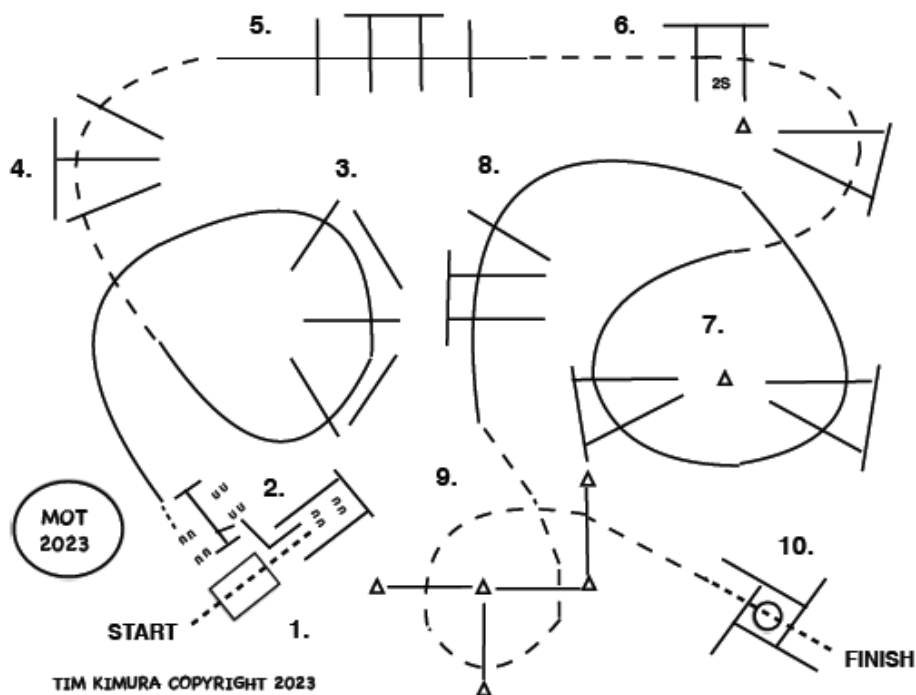

1. WALK OVER BRIDGE, WALK INTO CHUTE, BACK UP TO GATE.
2. WORK GATE (RIGHT HAND).
3. YOU MAY WALK FORWARD, THEN LOPE OVER POLES (RIGHT LEAD).
4. BREAK TO THE JOG, JOG OVER POLES.
5. LOPE OVER POLES (RIGHT LEAD).
6. BREAK TO THE JOG, JOG OVER POLES.
7. LOPE OVER POLES (LEFT LEAD).
8. LOPE OVER POLES (LEFT LEAD).
9. BREAK TO THE JOG, JOG THROUGH SERPENTINE, JOG OVER POLES.
10. STOP OR BREAK TO THE WALK, WALK INTO BOX, EXECUTE A 360 TURN EITHER WAY. WALK OUT BOX.



EUROPEAN APPALOOSA

**2023 APPALOOSA
EUROPEAN CHAMPIONSHIP**

**ApHC YOUTH TRAIL
ApHC JUNIOR TRAIL**

SATURDAY, SEPTEMBER 2

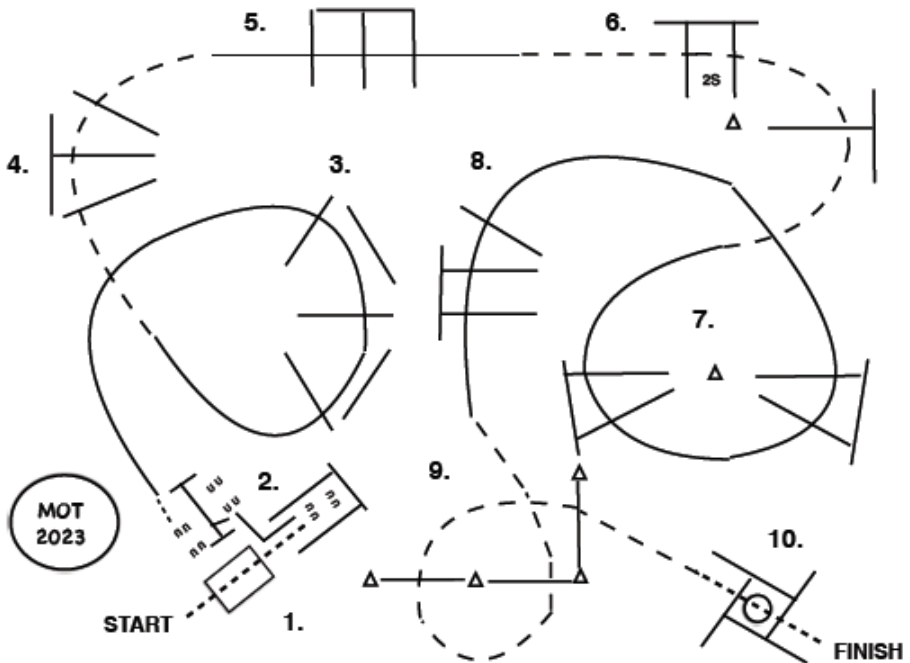

TIM KIMURA COPYRIGHT 2023

1. WALK OVER BRIDGE, WALK INTO CHUTE, BACK UP TO GATE.
2. WORK GATE (RIGHT HAND).
3. YOU MAY WALK FORWARD, THEN LOPE OVER POLES (RIGHT LEAD).
4. BREAK TO THE JOG, JOG OVER POLES.
5. LOPE OVER POLES (RIGHT LEAD).
6. BREAK TO THE JOG, JOG OVER POLES.
7. LOPE OVER POLES (LEFT LEAD).
8. LOPE OVER POLES (LEFT LEAD).
9. BREAK TO THE JOG, JOG THROUGH SERPENTINE, JOG OVER POLES.
10. STOP OR BREAK TO THE WALK, WALK INTO BOX, EXECUTE A 360 TURN EITHER WAY, WALK OUT BOX.



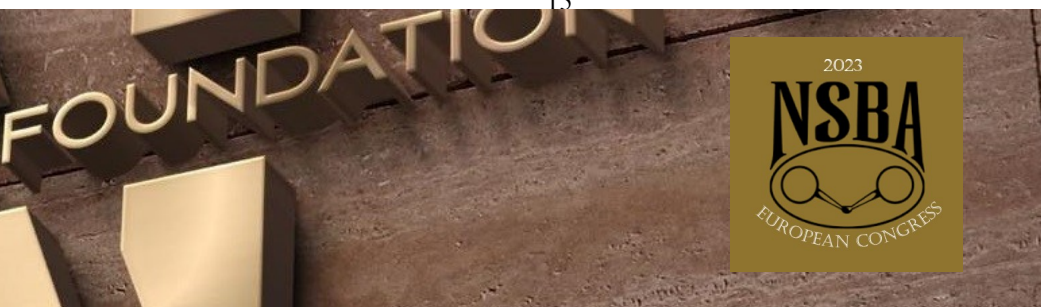

2023 APPALOOSA
EUROPEAN CHAMPIONSHIP

THURSDAY, AUGUST 31

NSBA GREEN TRAIL
NSBA NOVICE AMATEUR TRAIL
NSBA NOVICE YOUTH TRAIL

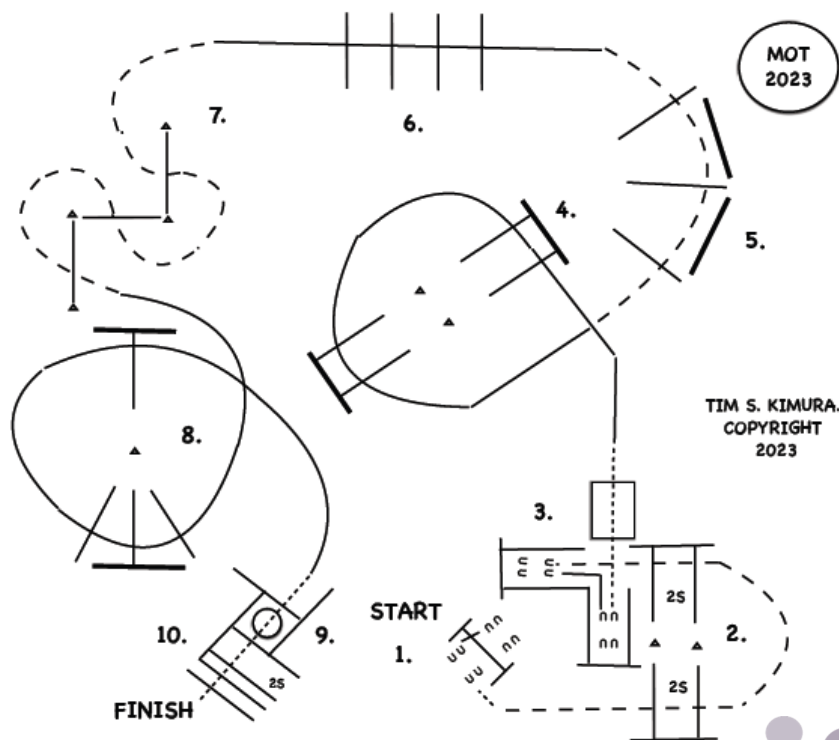

1. WORK GATE LEFT HAND, OPEN, WALK OVER POLE, CLOSE GATE.
2. YOU MAY WALK FORWARD, THEN JOG OVER POLES, JOG INTO AND STOP IN CH
3. BACK AN "L" AROUND CORNER IN BETWEEN POLES.
WALK FORWARD, WALK OVER BRIDGE.
4. LOPE OVER POLES (LEFT LEAD).
5. BREAK TO THE JOG, JOG OVER POLES.
6. LOPE OVER POLES (LEFT LEAD).
7. BREAK TO THE JOG, JOG THROUGH SERPENTINE, JOG OVER POLES.
8. LOPE OVER POLES (RIGHT LEAD).
9. STOP OR BREAK TO THE WALK, WALK INTO BOX, 360 EITHER WAY, WALK OUT BOX.
10. WALK OVER POLES.

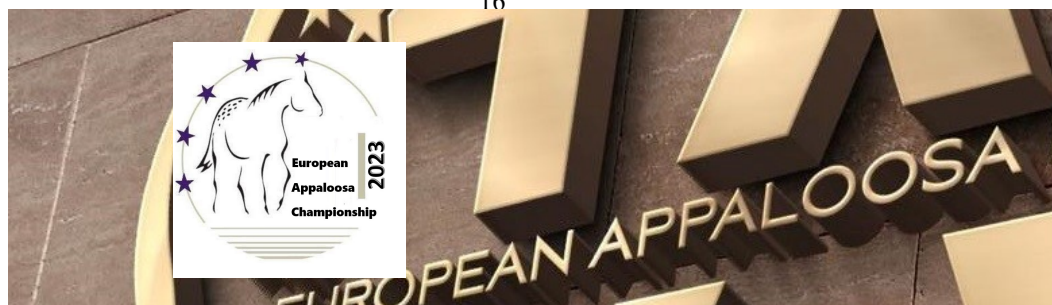

**2023 APPALOOSA
EUROPEAN CHAMPIONSHIP**

**EAF OPEN TRAIL FUTURITY
NSBA AMATEUR TRAIL**

SATURDAY, SEPTEMBER 2

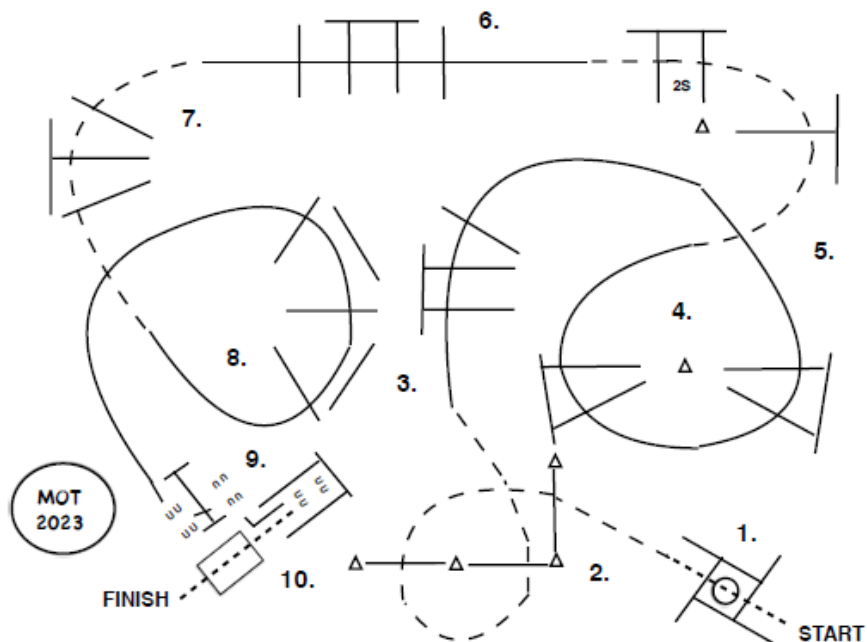

TIM KIMURA COPYRIGHT 2023

1. WALK INTO BOX, EXECUTE A 360 TURN EITHER WAY, WALK OUT BOX.
2. JOG THROUGH SERPENTINE, JOG OVER POLES.
3. LOPE OVER POLES (RIGHT LEAD).
4. LOPE OVER POLES (RIGHT LEAD).
5. BREAK TO THE JOG, JOG OVER POLES.
6. LOPE OVER POLES (LEFT LEAD).
7. BREAK TO THE JOG, JOG OVER POLES.
8. LOPE OVER POLES (LEFT LEAD), LOPE UP TO GATE.
9. WORK GATE LEFT HAND.
10. BACK AROUND CORNER BETWEEN POLES, WALK OUT OVER BRIDGE.





Trail Patterns by Tim Kimura are sponsored by :



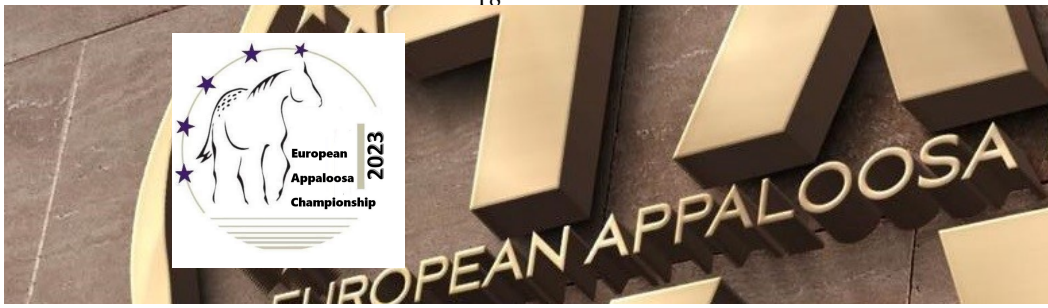

Showmanship Novice Youth & Novice Non-Pro/ Amateur

www.HorseShowPatterns.com

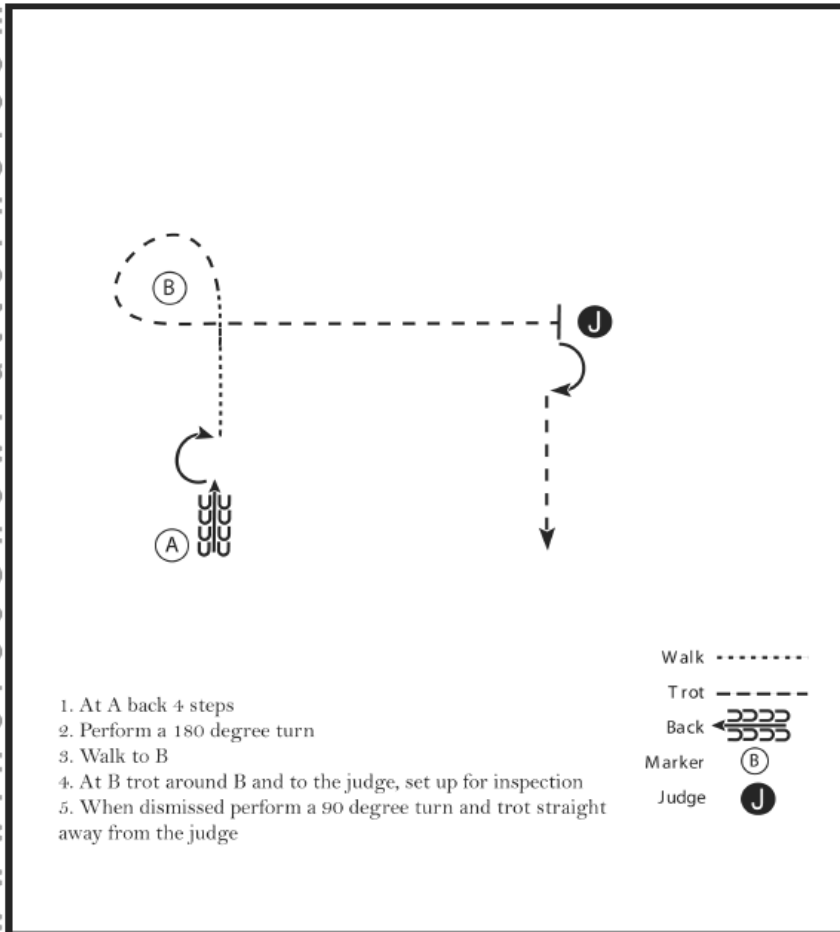

www.HorseShowPatterns.com



Showmanship Youth & Non-Pro/Amateur

www.HorseShowPatterns.com

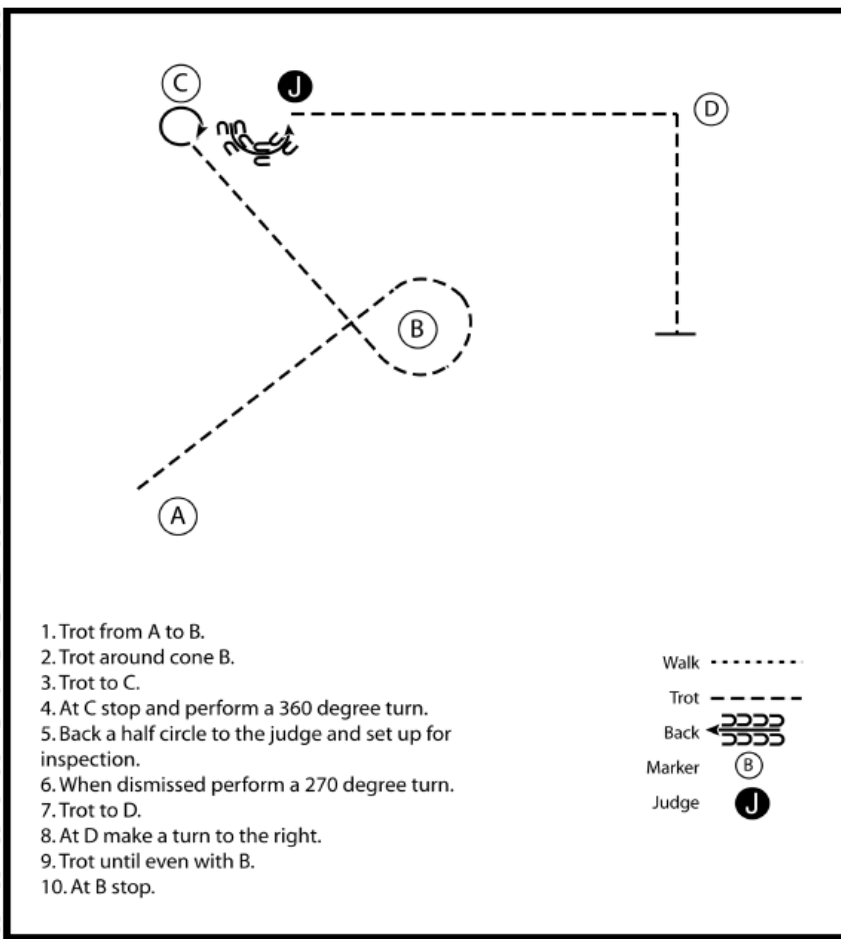

www.HorseShowPatterns.com

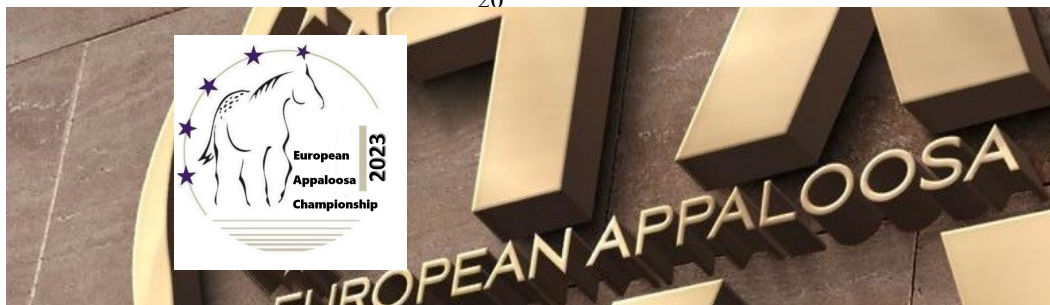

Hunt Seat Equitation Walk Trot Youth and Amateur

www.HorseShowPatterns.com

Be ready at A.

1. Walk from A until even with C.
2. Posting trot on the right diagonal to B.
3. At B, stop and perform a 90 degree turn on the forehand to the right.
4. Posting trot on the left diagonal from B to C.
5. At C stop and back approximately one horse length.

Follow the instructions of your ring steward.

Walk	-----
Trot	- - - - -
Extended Trot	—————
Canter	—————
Leg Yield	
Lead Change	///
Back	⋈
Marker	Ⓚ
Sidepass	← →
Hand Gallop	-----

www.HorseShowPatterns.com



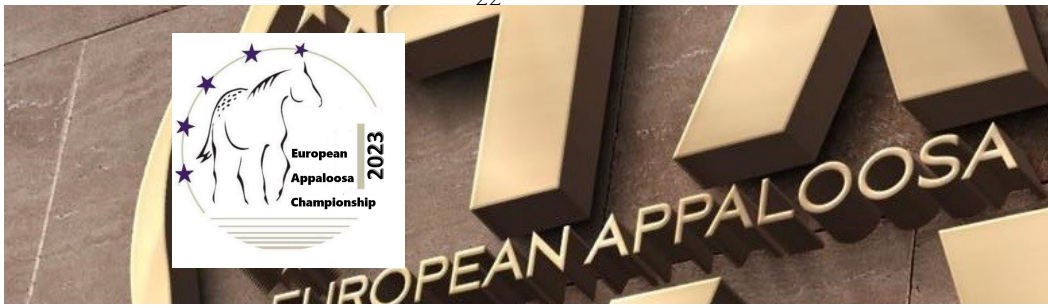

Hunt Seat Novice Youth and Novice Non Pro/Amateur

www.HorseShowPatterns.com

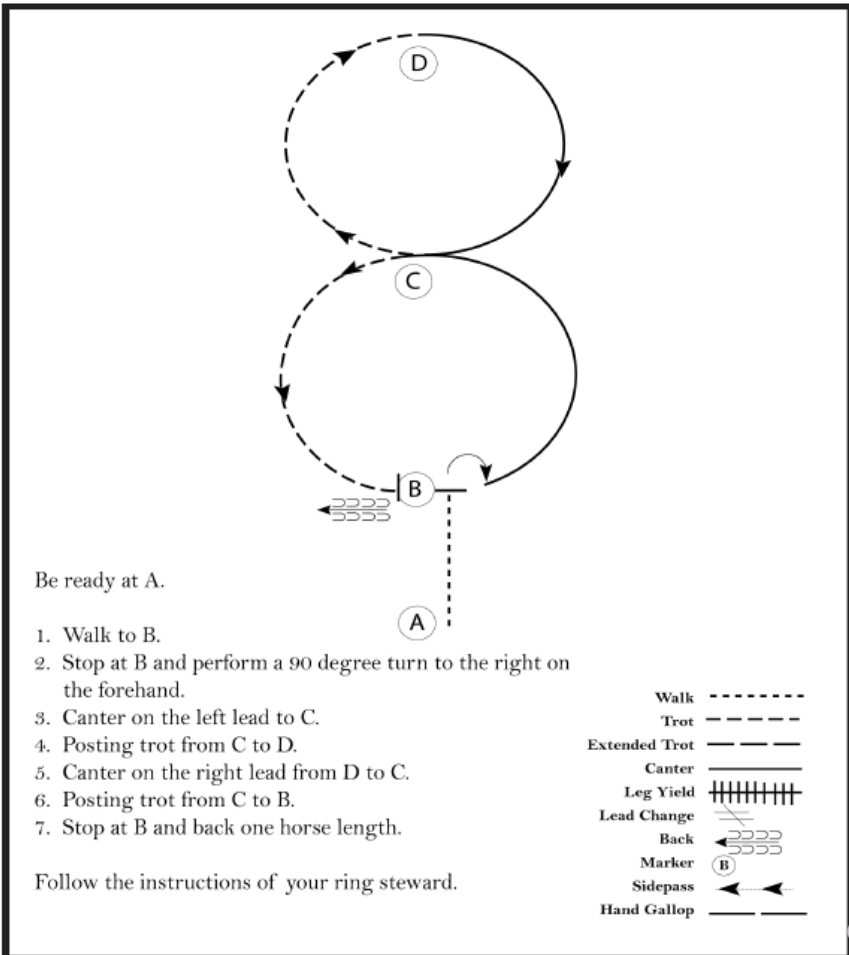

www.HorseShowPatterns.com



Hunt Seat Youth and Non Pro/Amateur

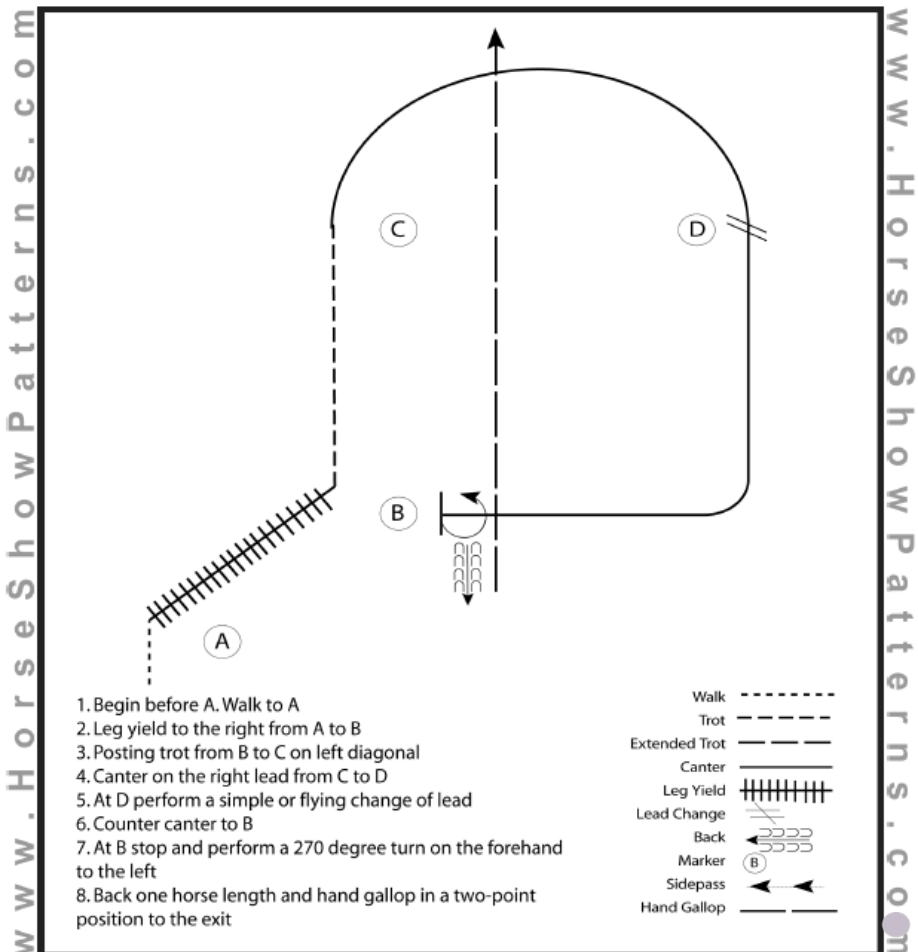

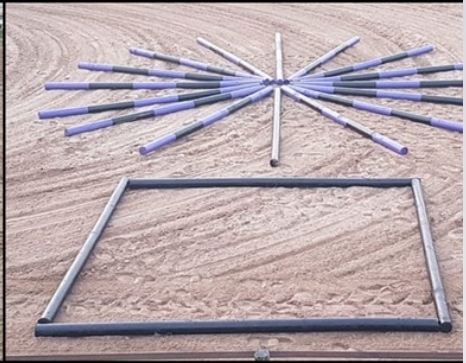
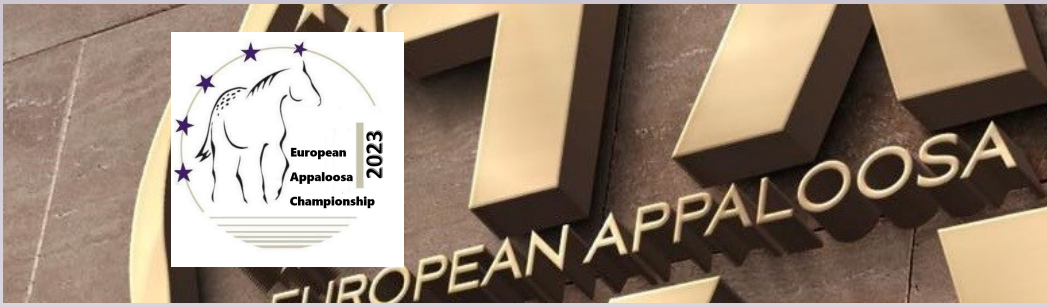

FOUNDATION



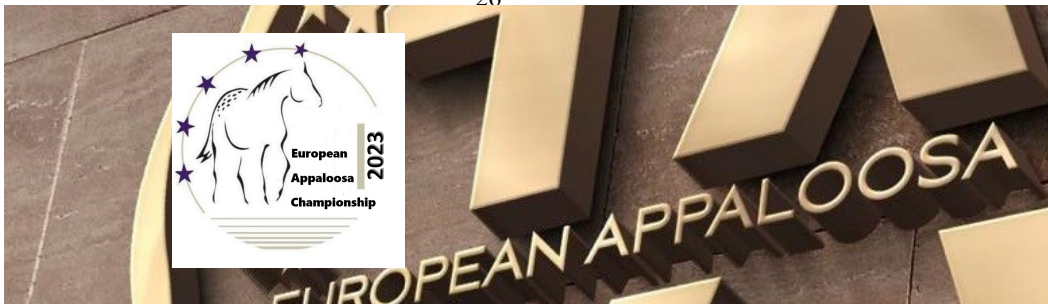

Ranch Riding Youth and Junior Open

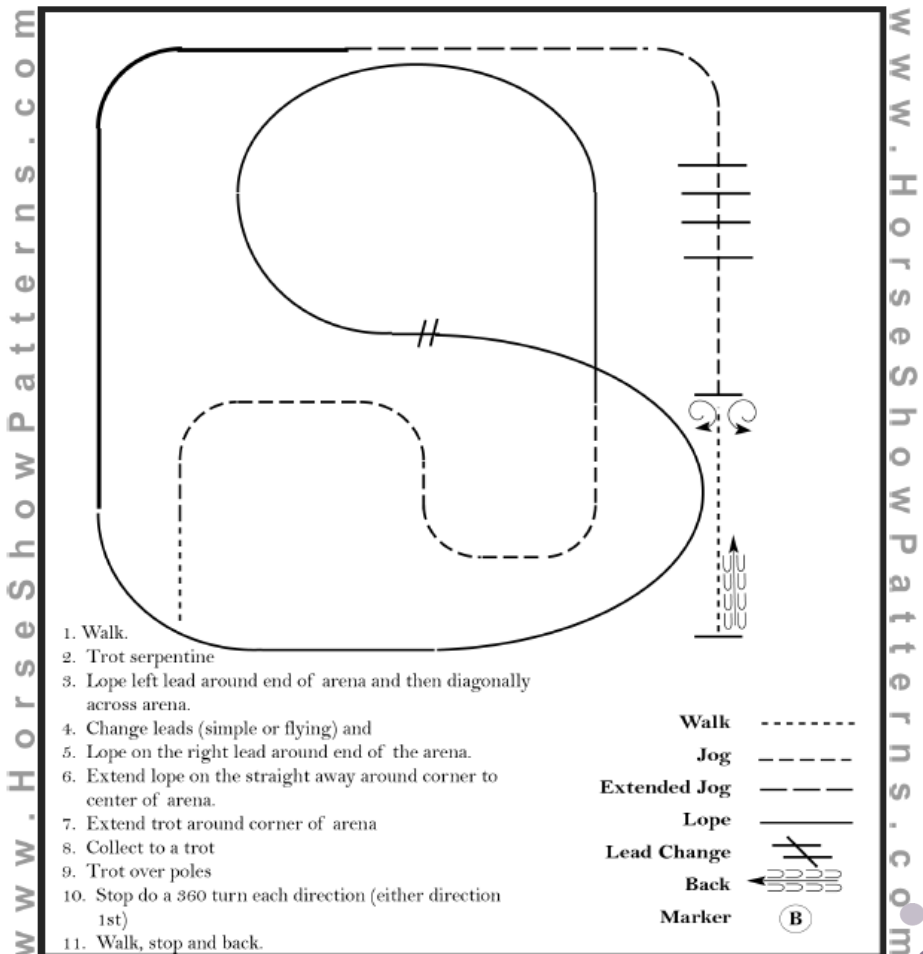



Ranch Riding Senior Open and NSBA Open

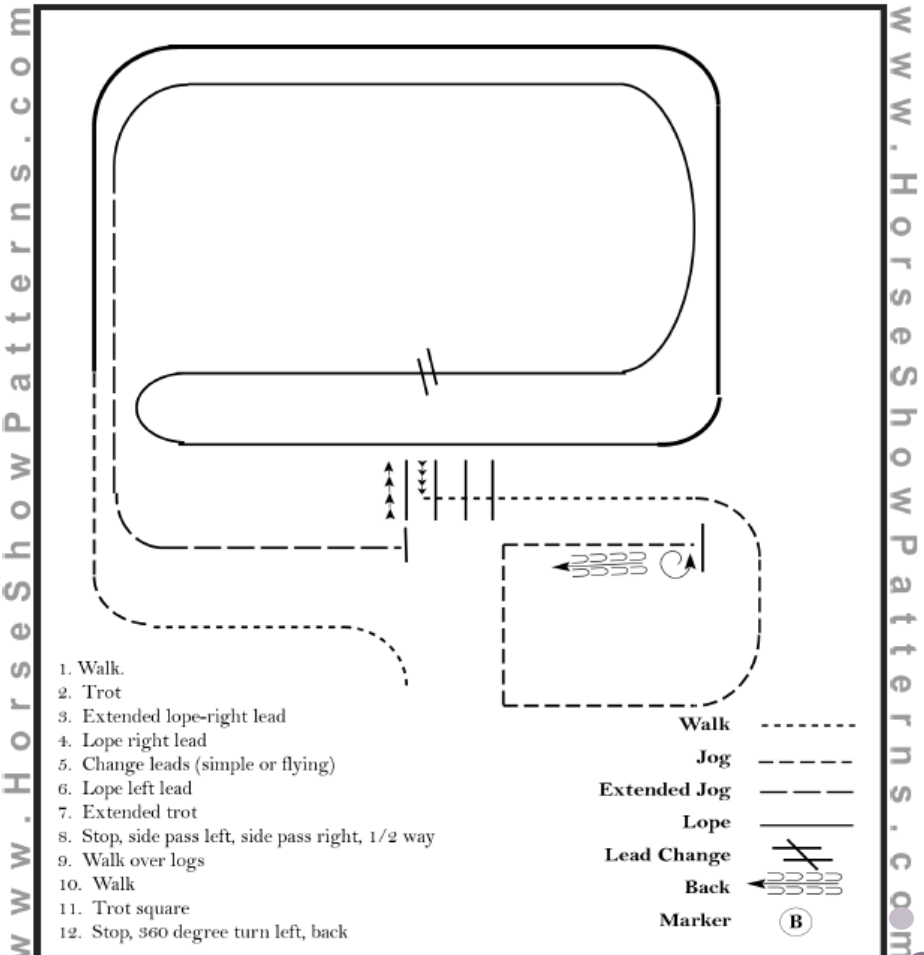

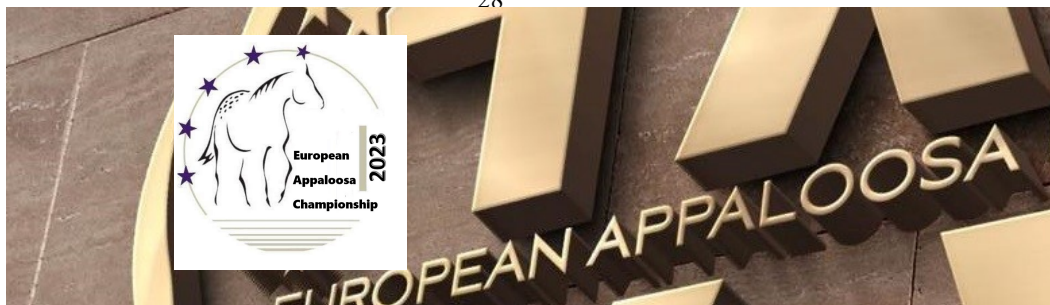

Ranch Riding Non Pro/Amateur and EAF Maturity

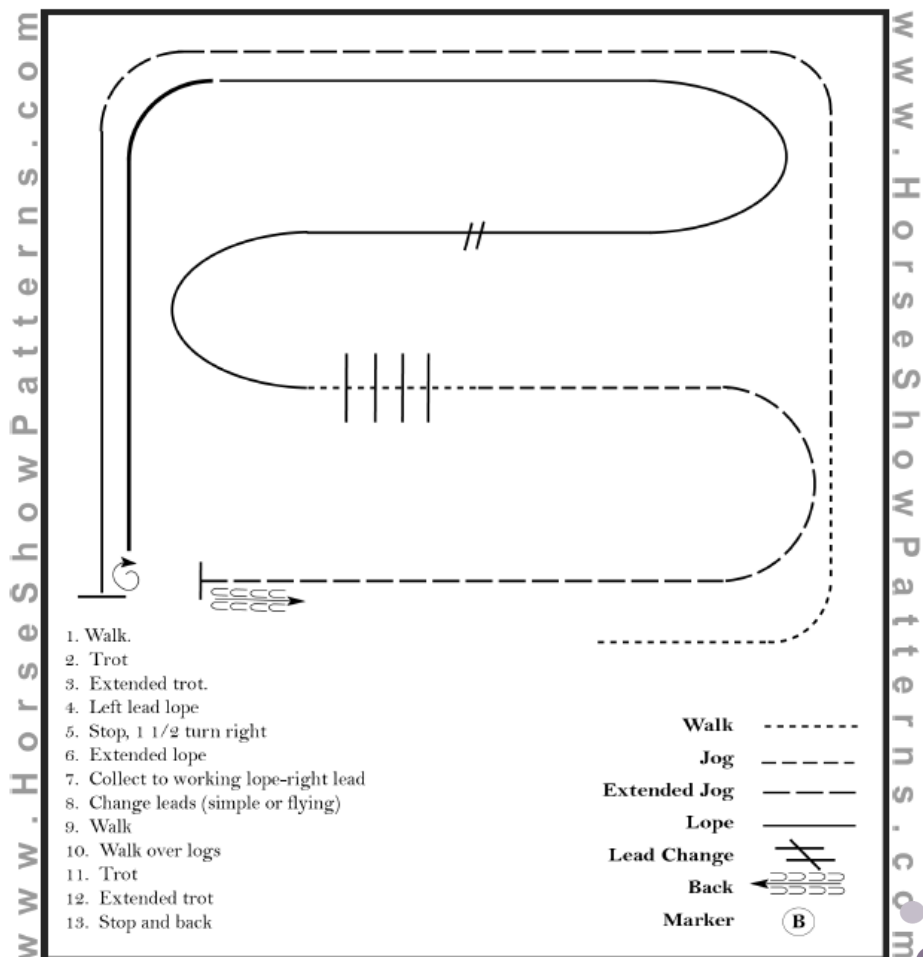



Ranch Riding NSBA Green, Novice Amateur, Novice Youth and EAF Futuritiy

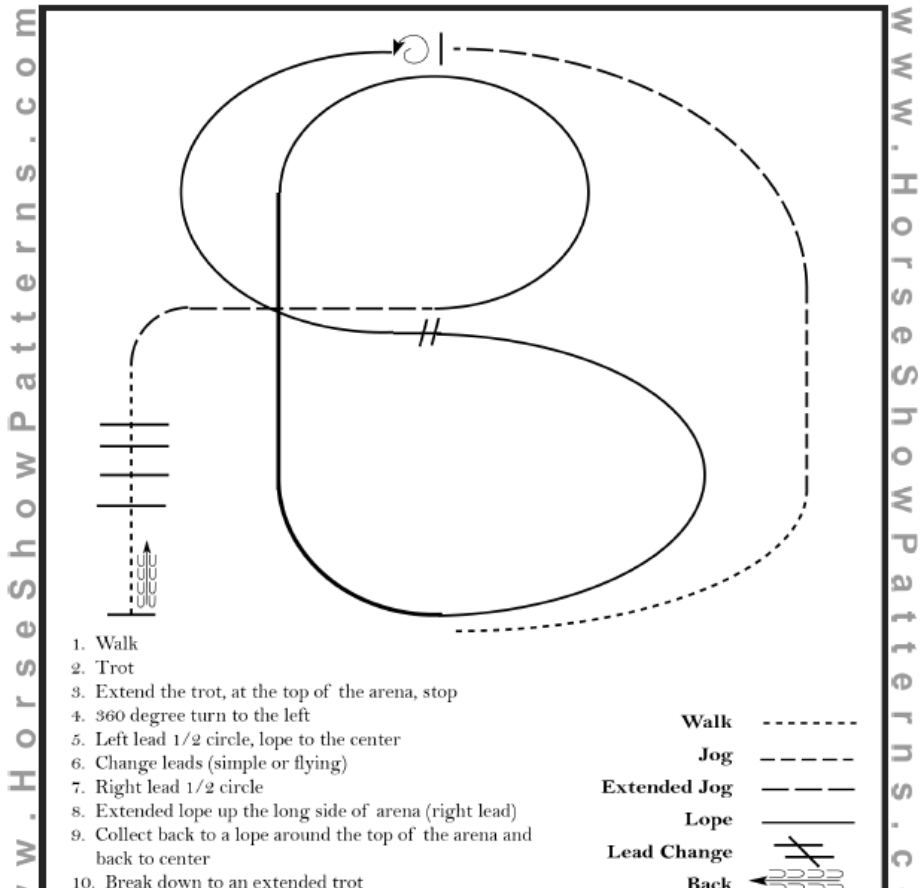



EUROPEAN APPALOOSA

Ranch Trail Green, Novice Youth and Novice Non Pro

- 1- Trot over logs
- 2- Walk over bridge
- Extended trot to gate
- 3- Work gate
- Lope right lead-Trot
- 4- Sidepass over logs
- Extended lope-Extended trot

- 5a-pick up 5b-put down
- Walk to logs
- 6-Sidepass over log
- Turn left-Back up-
- 7-Walk into square
- Turn 360 to the left
- Walk to exit.

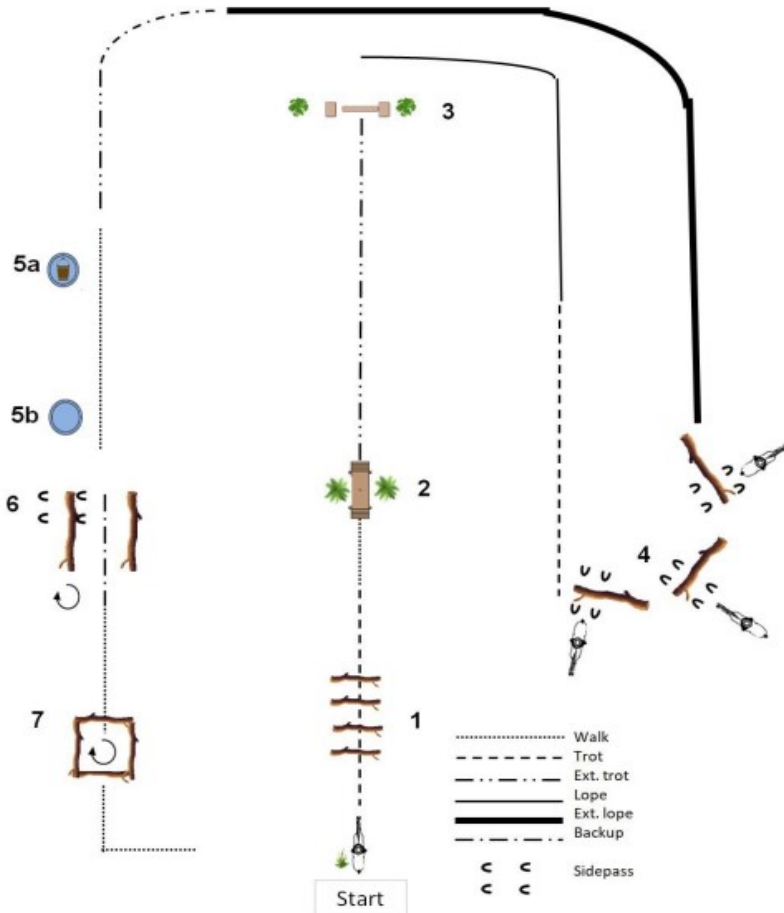

Pattern by Dutch Ranch Horse



WESTERNTRAINING & SADDLES
MAJA DEEB

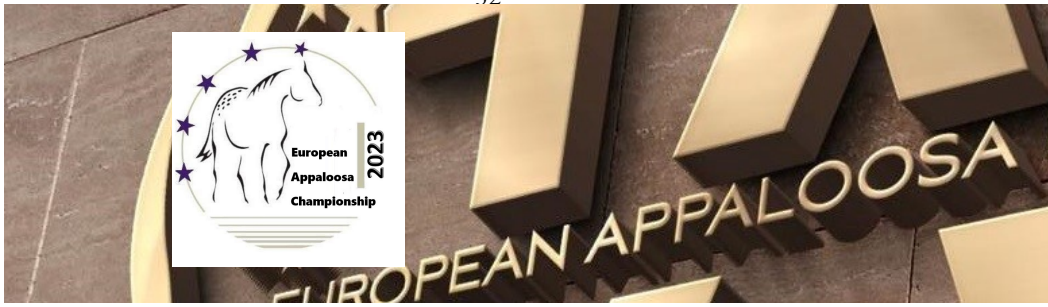



Ranch Trail Open AA, Youth and Non-Pro

- 1- Trot over logs
- 2- Walk over bridge
- Extended trot to gate
- 3- Work gate
- Lope right lead-Trot
- 4- Sidepass over logs
- Extended lope-Extended trot

- 5- Drag Log
- Walk to logs
- 6-Sidepass over log
- Turn left-Back up-
- 7-Rope the dummy, 1 time
- Walk to exit.

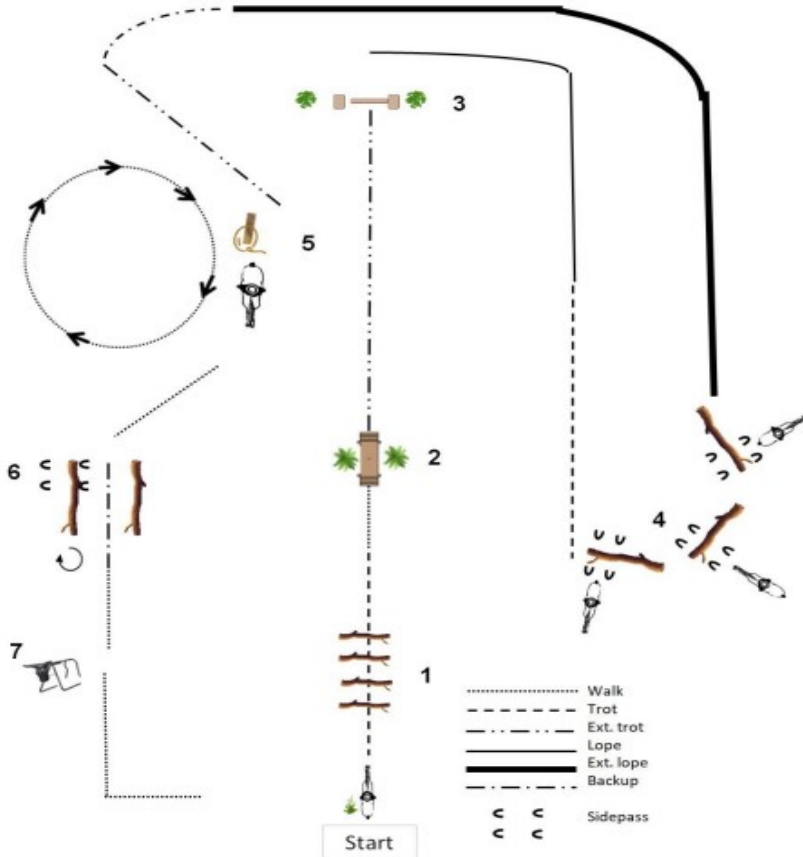

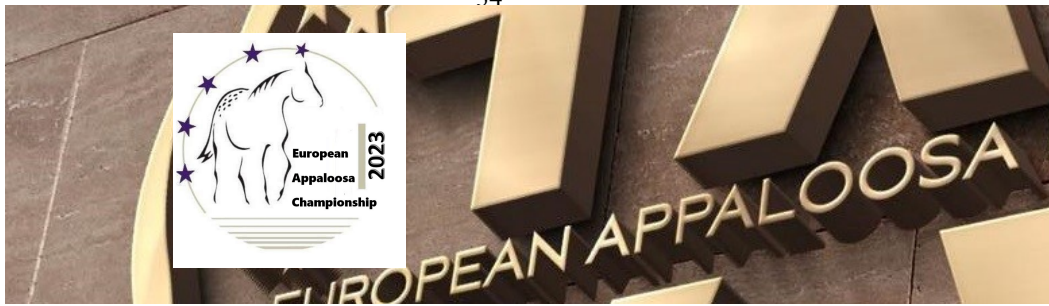

Reining Youth, Non Pro and Senior Open and EAF Futurity

www.HorseShowPatterns.com

www.HorseShowPatterns.com

REINING PATTERN 9

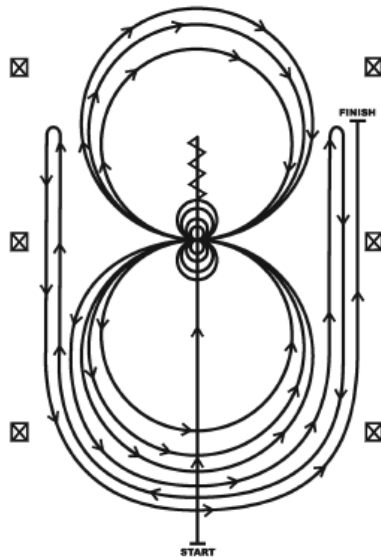

1. Run past the center marker and do a sliding stop. Back up to the center of the arena or at least ten feet (three meters). Hesitate.
2. Complete four spins to the right. Hesitate.
3. Complete four and one-quarter spins to the left so that horse is facing the left wall or fence. Hesitate.
4. Beginning on the left lead, complete three circles to the left: the first circle small and slow; the next two circles large and fast. Change leads at the center of the arena.
5. Complete three circles to the right: the first circle small and slow; the next two circles large and fast. Change leads at the center of the arena.
6. Begin a large circle to the left but do not close this circle. Run up the right side of the arena past the center marker and do a right rollback at least twenty feet (six meters) from the wall or fence—no hesitation.
7. Continue back around the previous circle but do not close this circle. Run up the left side of the arena past the center marker and do a left rollback at least twenty feet (six meters) from the wall or fence—no hesitation.
8. Continue back around previous circle but do not close this circle. Run up right side of the arena past the center marker and do a sliding stop at least twenty feet (six meters) from the wall or fence. Hesitate to demonstrate completion of the pattern.



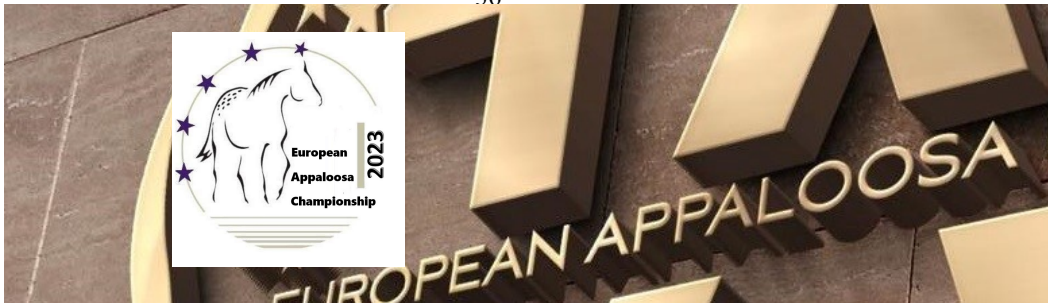

Reining Novice Youth, Novice Non Pro, Junior Open and EAF Futurity

www.HorseShowPatterns.com

REINING PATTERN 6

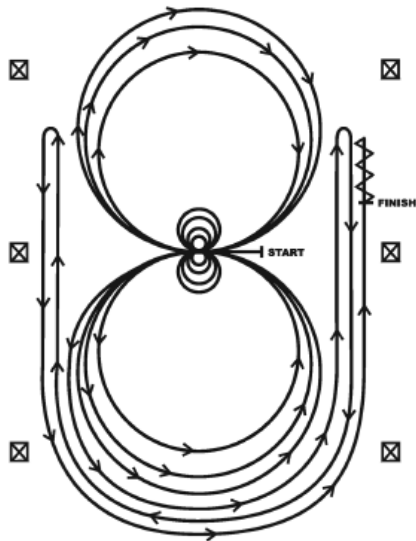

Horses may walk or jog to the center of arena. Horses must walk or stop prior to starting pattern. Beginning at the center of the arena facing the left wall or fence.

1. Complete four spins to the right. Hesitate.
2. Complete four spins to the left. Hesitate.
3. Beginning on the left lead, complete three circles to the left: the first two circles large and fast; the third circle small and slow. Change leads at the center of the arena.
4. Complete three circles to the right: the first two circles large and fast; the third circle small and slow. Change leads at the center of the arena.
5. Begin a large circle to the left but do not close this circle. Run up the right side of the arena past the center marker and do a right rollback at least twenty feet (six meters) from the wall or fence—no hesitation.
6. Continue back around previous circle but do not close this circle. Run up the left side of the arena past the center marker and do a left rollback at least twenty feet (six meters) from the wall or fence—no hesitation.
7. Continue back around previous circle but do not close this circle. Run up the right side of the arena past the center marker and do a sliding stop at least twenty feet (six meters) from the wall or fence. Back up at least ten feet (three meters). Hesitate to demonstrate the completion of the pattern.

www.HorseShowPatterns.com

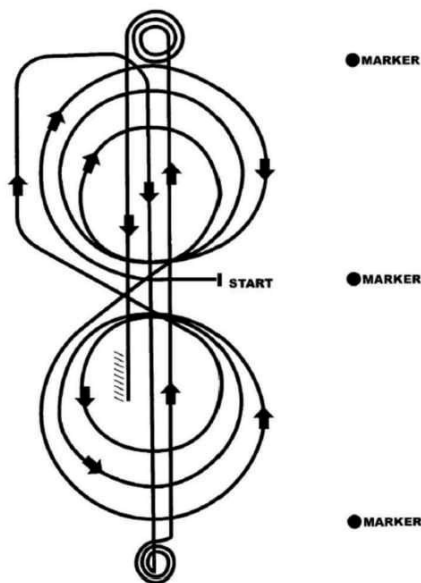

Ranch Reining

RANCH REINING PATTERN 3

Mandatory Marker along Fence or Wall: The judge shall indicate with markers on arena fence or wall the center of pattern. Judge shall also place markers on fence or wall at least 50' from each end of the arena.

Ride pattern as follows: Trot to center of arena and stop or walk before departure. Start pattern facing toward judge.

1. Beginning on right lead, complete three circles to the right - the first two large and fast; the third one small and slow. Change leads at center of arena.
2. Complete three circles to the left - the first two large and fast; the third one small and slow. Change leads at center of arena.
3. Begin a large circle to the right, but do not close this circle. Run down center of arena, past the end marker, and do a sliding stop.
4. Complete 3 1/2 spins to the right.
5. Run up center of arena to the opposite end, past the end marker, do a sliding stop.
6. Complete 3 1/2 spins to the left.
7. Run back to the middle of the arena, past the center marker, and do a sliding stop. Back up at least 10 feet. Hesitate to show completion of pattern.



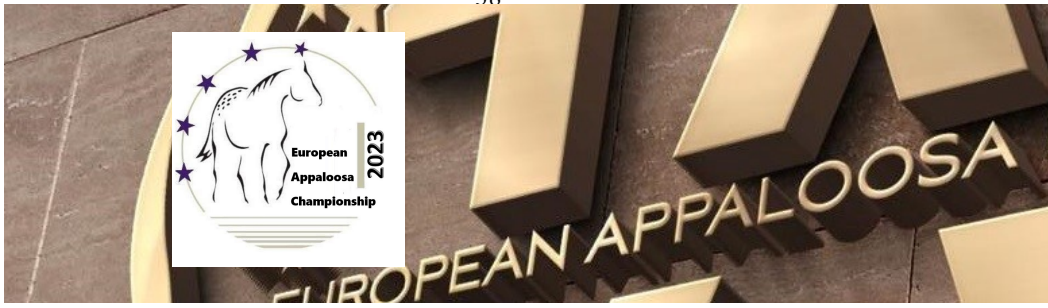

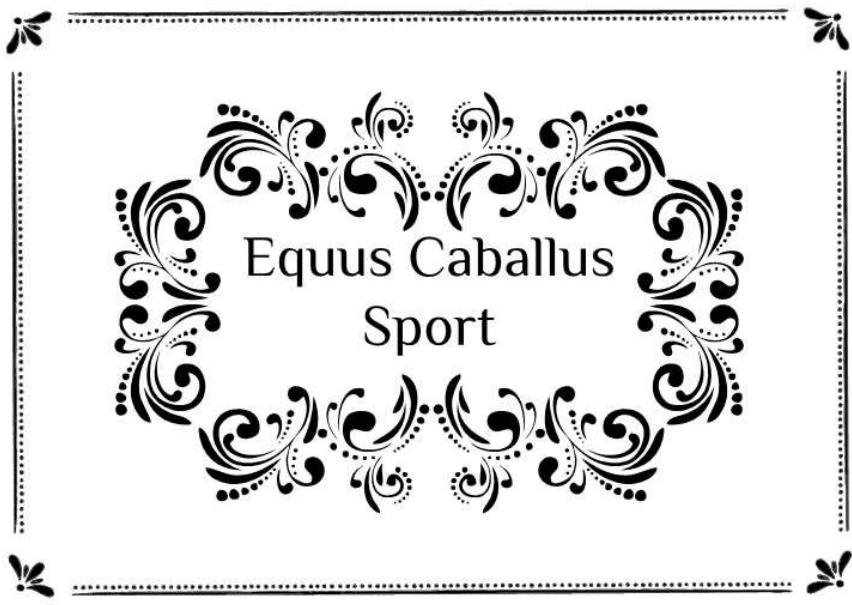

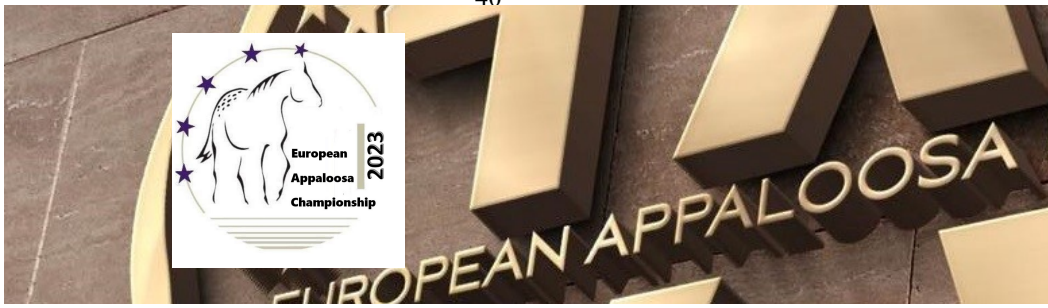

Western Horsemanship Novice Youth

www.HorseShowPatterns.com

www.HorseShowPatterns.com

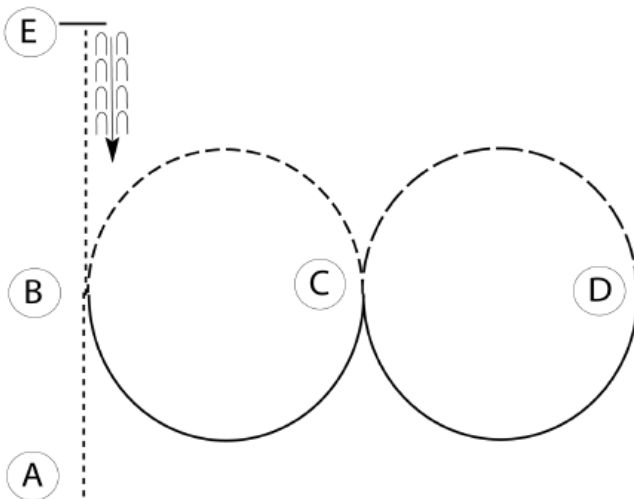

Be ready at A.

1. Walk A to B.
2. Jog a half circle to C.
3. Lope a half circle on the left lead to D.
4. Extend the jog in a half circle to B.
5. Lope a half circle on the right lead to B.
6. Walk to E.
7. Stop at E and back approximately one horse length.

Follow the instructions of your ring steward.

Walk	-----
Jog	- - - - -
Extended Jog	— — — — —
Lope	— — — — —
Lead Change	
Back	
Marker	(B)



Western Horsemanship Youth and Novice Non Pro/ Amateur

www.HorseShowPatterns.com

www.HorseShowPatterns.com

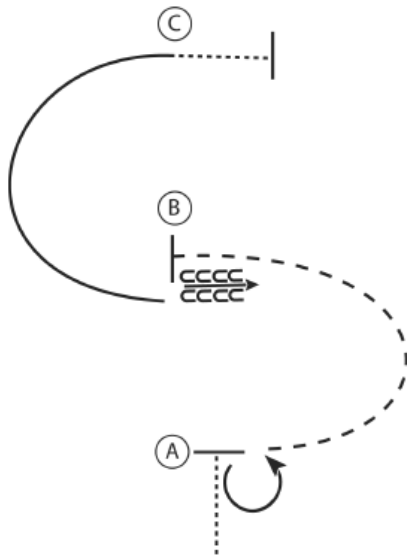

1. Walk to A
2. Stop at A and perform a 270 degree turn to the left
3. Jog a half circle to B
4. Stop at B and back 3 steps
5. Lope a half circle to C on the left lead
6. At C walk 5 steps and stop

- Walk (dotted line)
- Jog - - - - - (dashed line)
- Extended Jog - - - - - (long dashed line)
- Lope ———— (solid line)
- Leg Yield ||||| (vertical bars)
- Lead Change / (diagonal slash)
- Back < C C C C C (backward arrows)
- Marker (B) (circle with B)
- Sidepass < - - - - - (dashed line with arrow)

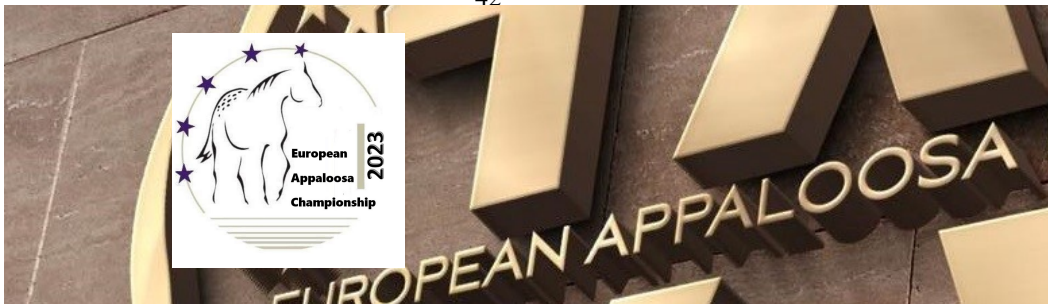

Western Horsemanship Bareback Youth and Non Pro/ Amateur

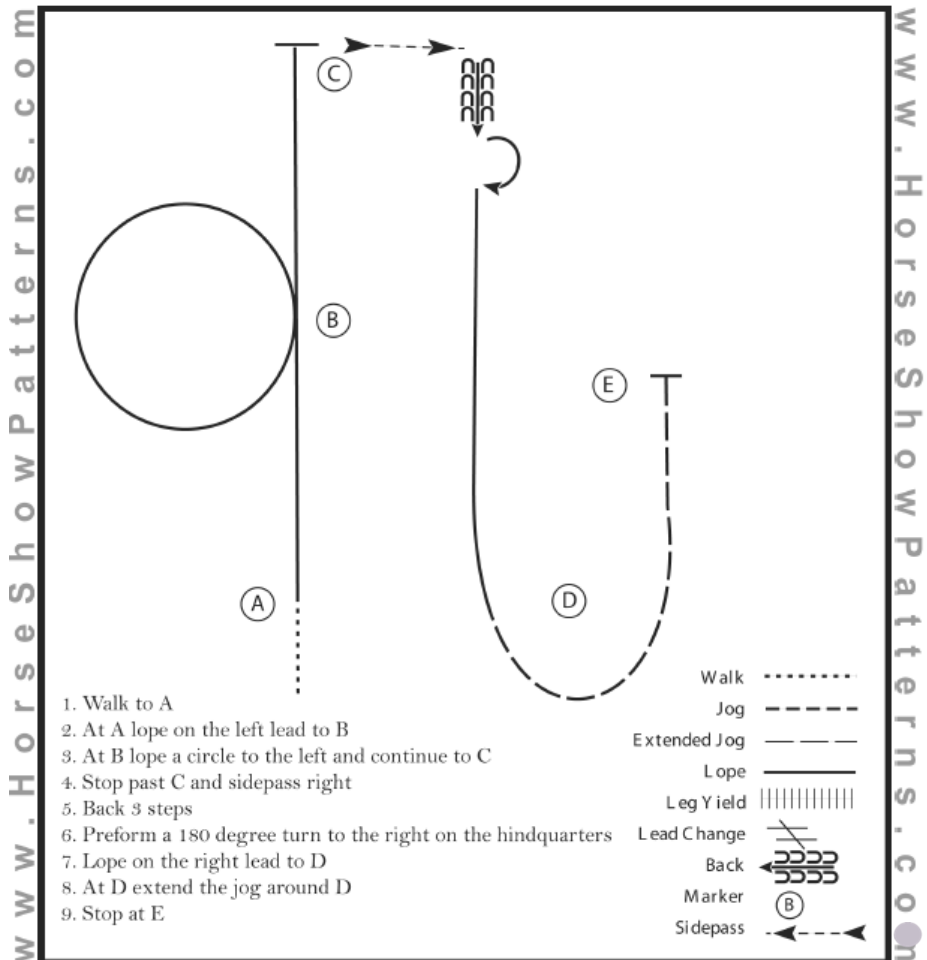



Western Horsemanship W/T Youth and Amateur

www.HorseShowPatterns.com

www.HorseShowPatterns.com

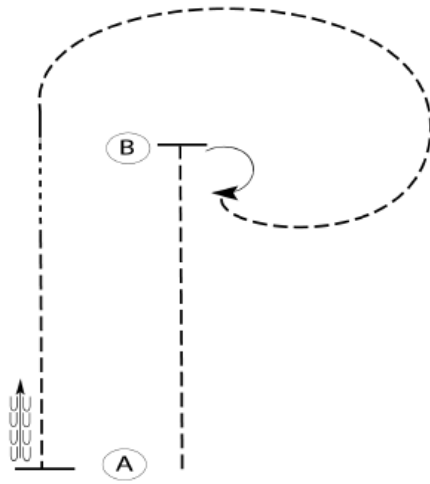

Be ready at A.

1. Jog to B.
2. Turn 180 degrees to the right.
3. Jog back around to B.
4. At B, break to the walk.
5. Walk approximately 10 feet.
6. Jog to A.
7. Stop at A and back approximately one horse length.

Follow the instructions of your steward.

- Walk -----
- Jog - - - - -
- Extended Jog - - - - -
- Lope _____
- Leg Yield |||||
- Lead Change ↘ ↙
- Back ← ○○○○
- Marker ○ B
- Sidepass ← →



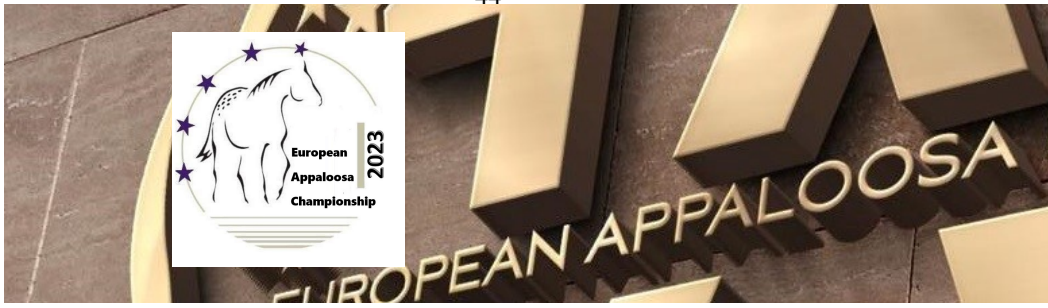



Western Horsemanship Non Pro / Amateur

www.HorseShowPatterns.com

www.HorseShowPatterns.com

Be ready at A.

1. Perform an extended jog from A and a square corner toward center of pattern.
2. Stop in center and perform a 1 1/4 turn right.
3. Lope a right lead square.
4. Change leads at center and lope a left lead circle.
5. Close the circle and continue loping on the left lead in a straight line.
6. Stop and perform a 1 1/4 turn to the left.
7. Back approximately one horse length
8. Walk until you cross your line.
9. Exit arena at a jog.

Walk
Jog	-----
Extended Jog	-----
Lope	————
Lead Change	////
Back	←○○○○○
Marker	ⓐ

www.HorseShowPatterns.com

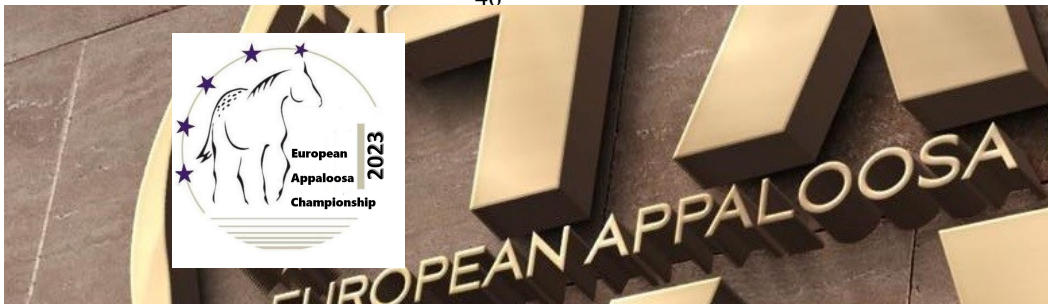

Western Riding Open AA, Youth & Non Pro/ Amateur

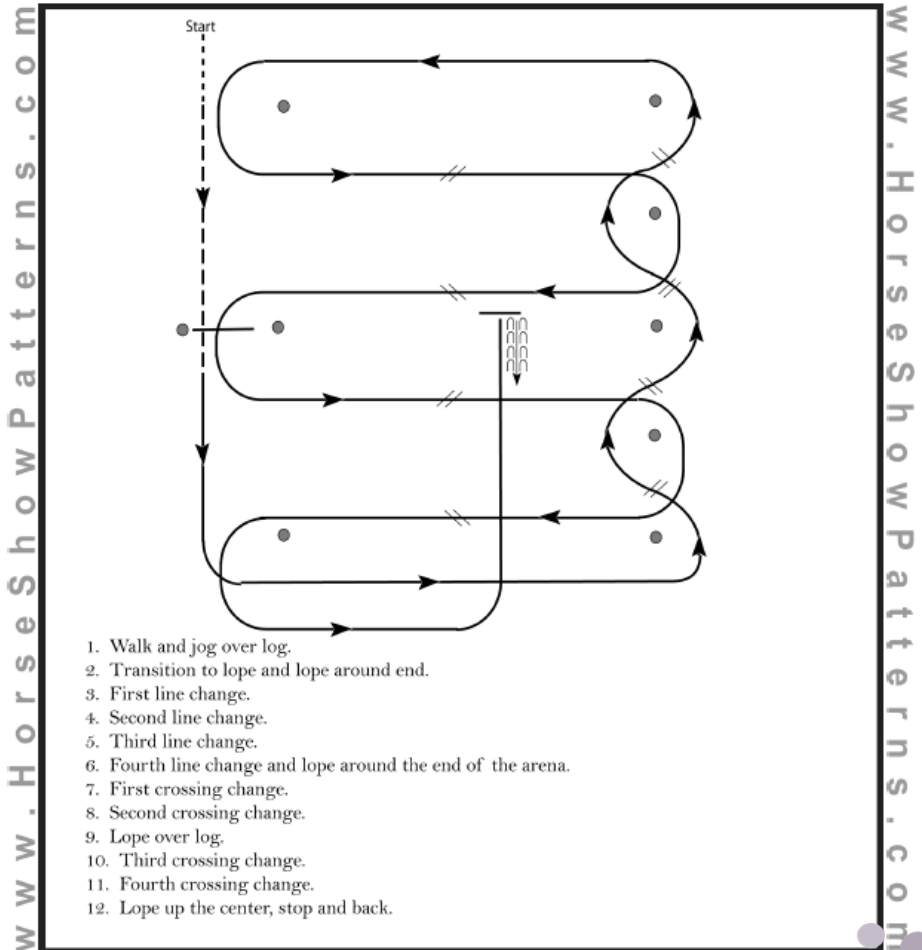



Green Western Riding, Novice Youth and Novice Non-Pro/Amateur

www.HorseShowPatterns.com

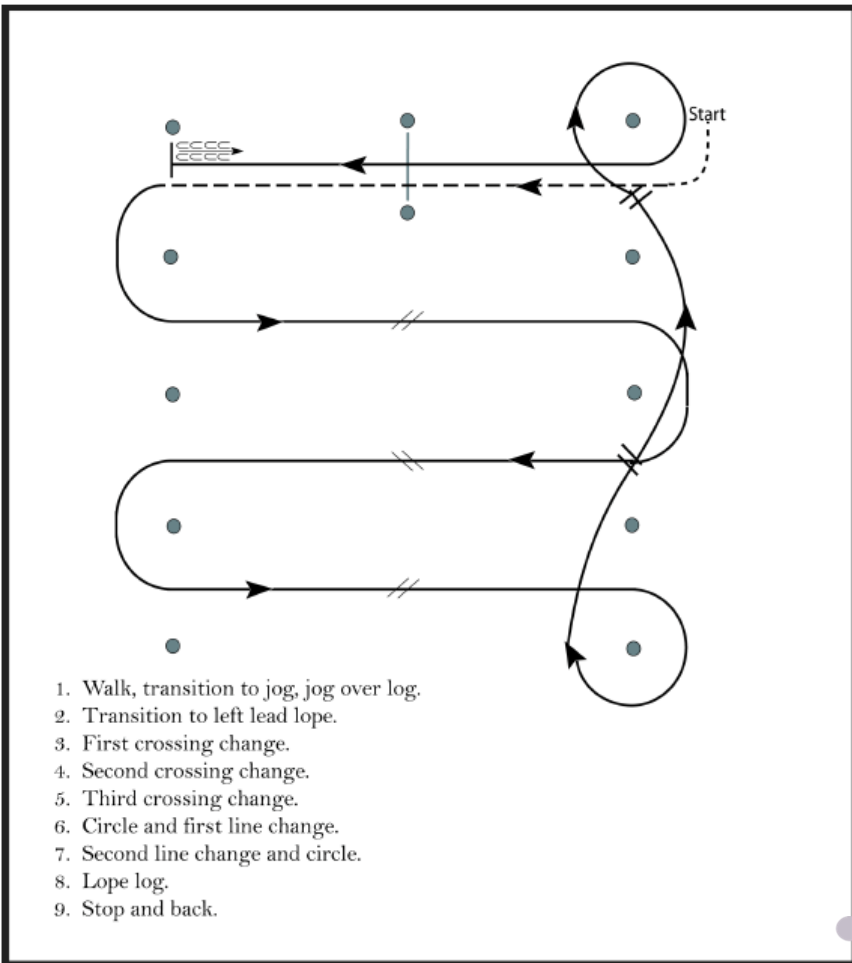

1. Walk, transition to jog, jog over log.
2. Transition to left lead lope.
3. First crossing change.
4. Second crossing change.
5. Third crossing change.
6. Circle and first line change.
7. Second line change and circle.
8. Lope log.
9. Stop and back.

www.HorseShowPatterns.com

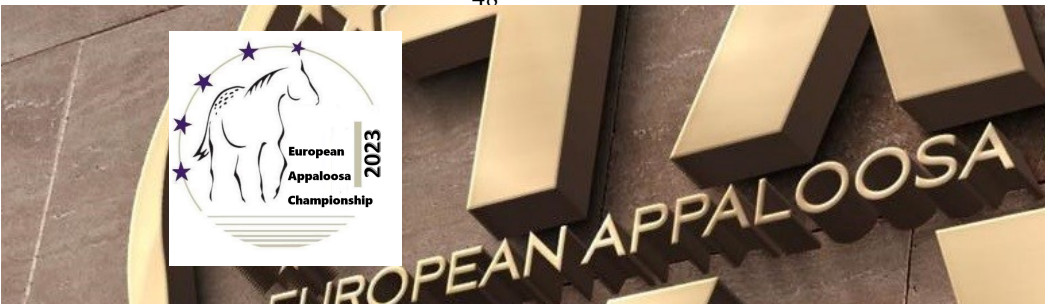

Versatility Challenges

18-23 October 2022





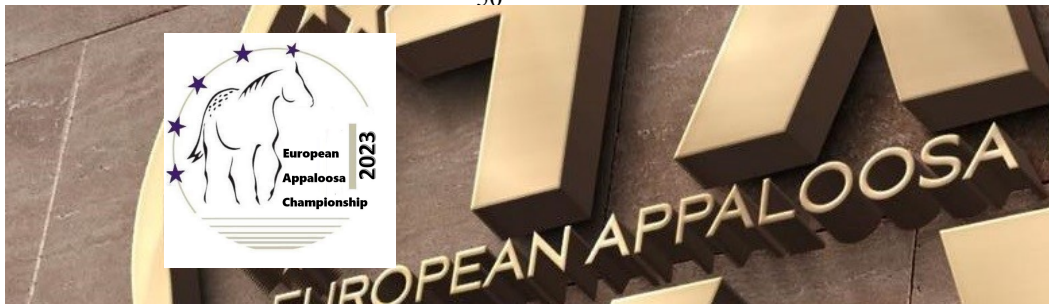

Ranch Versatility Challenge

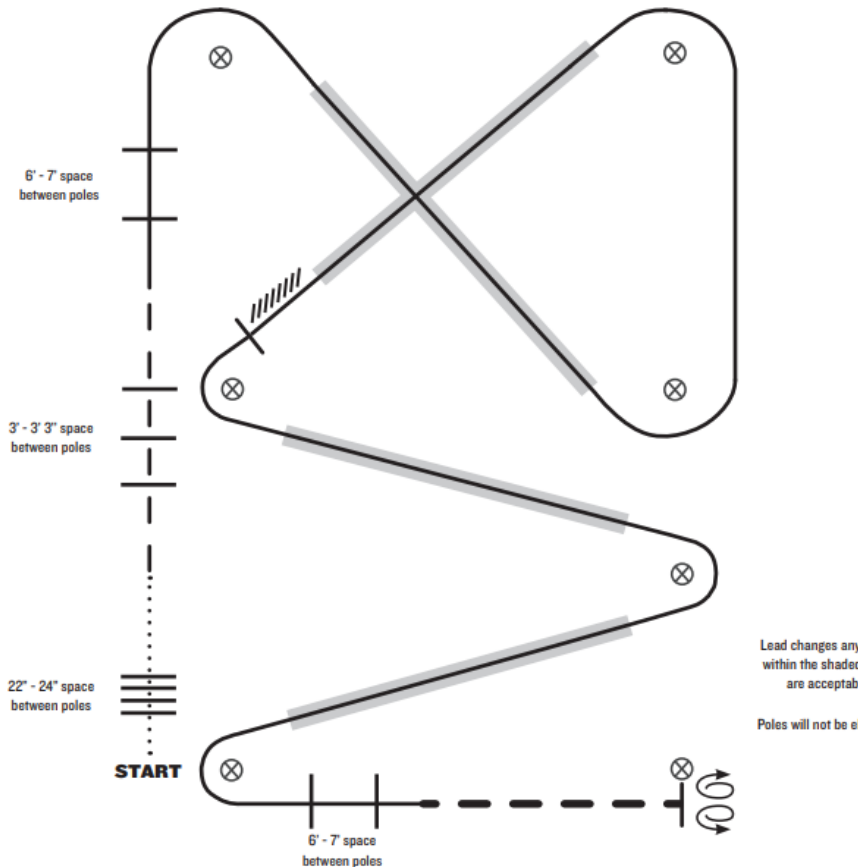

1. Enter at a walk and walk over 4 poles
2. Break to a jog and lope over 3 poles
3. Perform a right lead lope and lope over 2 poles
4. Perform a true right lead and perform a right-to-left lead change (flying or simple)
5. Perform a left-to-right lead change (flying or simple)
6. Turn back at least 5 steps, depart left lead
7. Perform a left-to-right lead change (flying or simple)
8. Perform a right-to-left lead change (flying or simple)

9. Lope left lead over 2 poles
10. Break to moderate extension of jog
11. Stop and settle
12. Perform 360° turn in either direction, then perform 360° turn in opposite direction

Dismount at exit gate and remain dismounted until pleasure warm-up begins.



Pleasure Versatility Challenge

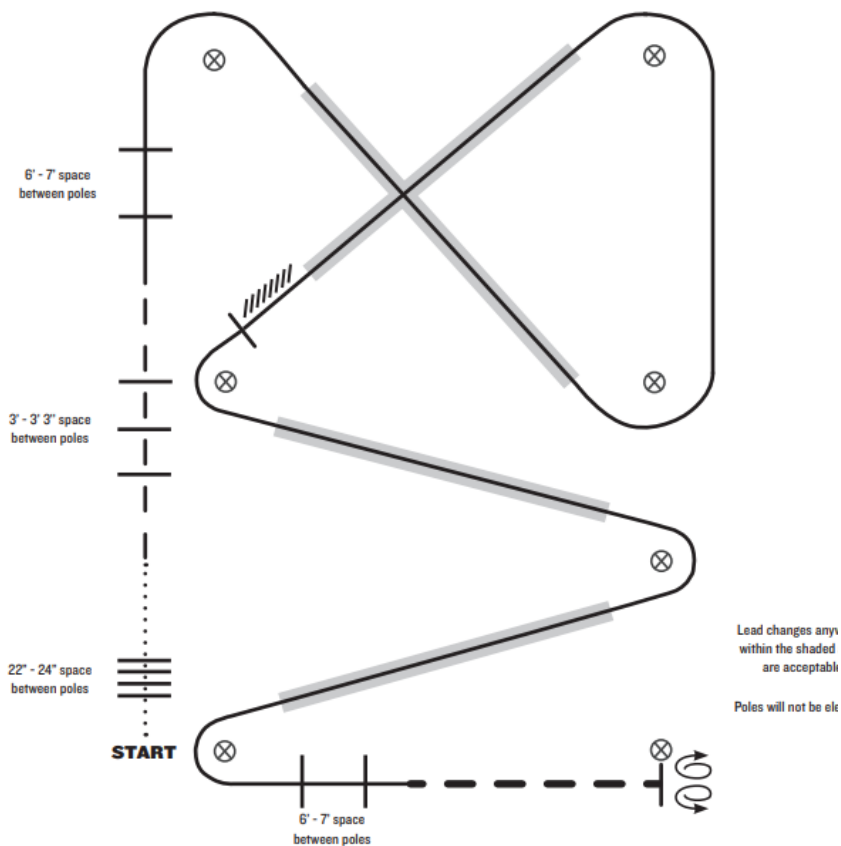

9. Enter at a walk and walk over 4 poles
10. Break to moderate extension of jog over 3 poles
11. Perform right lead lope and lope over 2 poles
12. Perform right lead and perform a right-to-left lead change (flying or simple)
13. Perform a left-to-right lead change (flying or simple)
14. Perform a left-to-right lead change (flying or simple)
15. Perform a right-to-left lead change (flying or simple)

9. Lope left lead over 2 poles
10. Break to moderate extension of jog
11. Stop and settle
12. Perform 360° turn in either direction, then perform 360° turn in opposite direction

Dismount at exit gate and remain dismounted until pleasure warm-up begins.

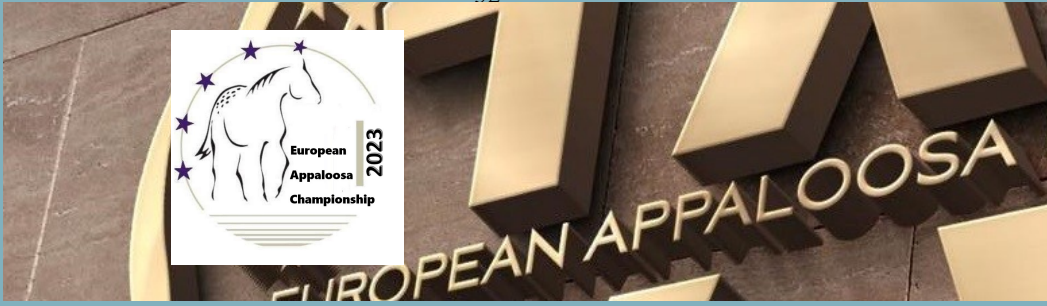

Inside Quarterhorses







Thanks to all our
sponsors!

